

ASSEMBLY AND INSTALLATION INSTRUCTIONS

H0012 / H0023

WARNING: BE SURE TO SHUT OFF POWER AT THE MAIN FUSE OR CIRCUIT BREAKER BOX BEFORE INSTALLING OR SERVICING THIS FIXTURE.

**NOTE: 1. Before installing, consult local electrical codes for wiring and grounding requirements.
2. READ AND SAVE THESE INSTRUCTIONS.**

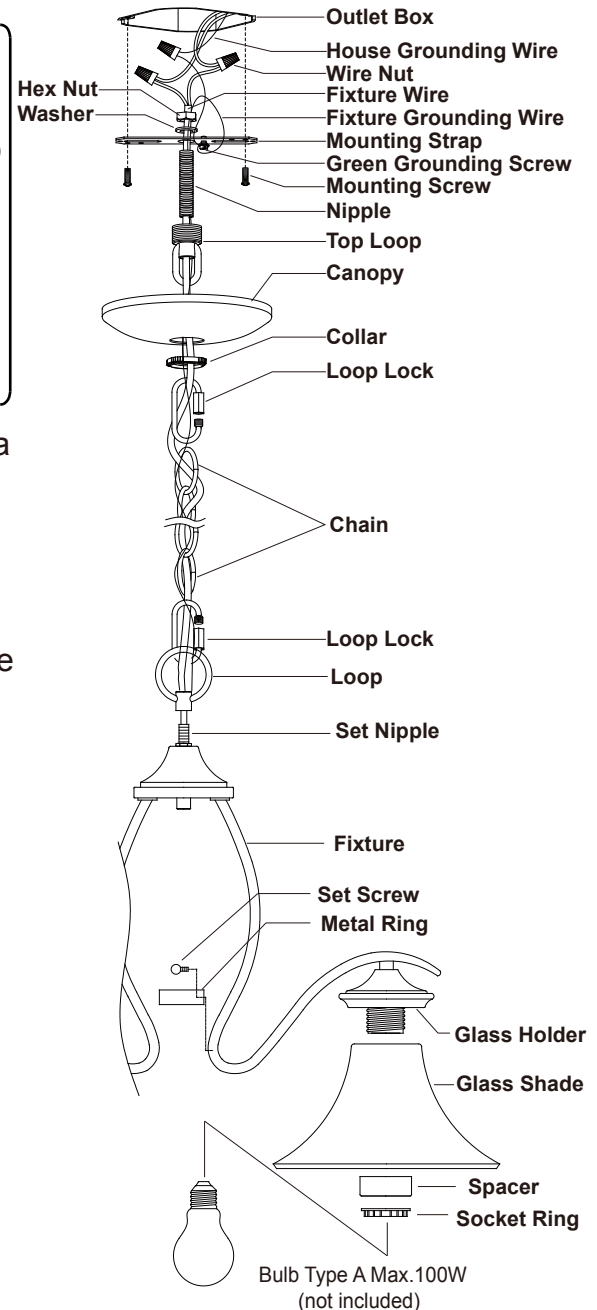
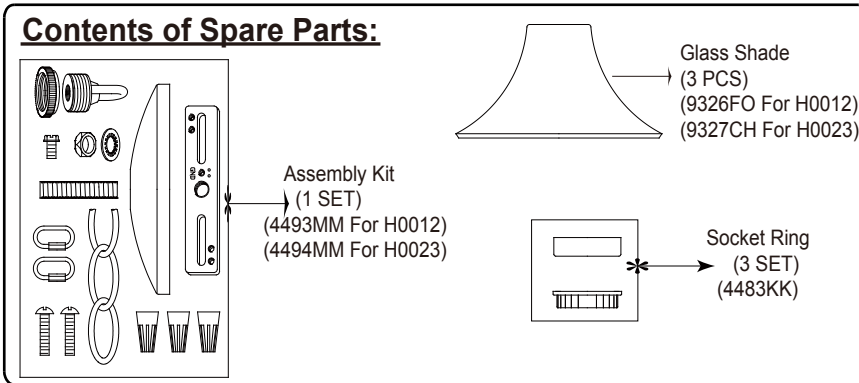

1. Attach the nipple to the mounting strap, then secure it with a washer and hex nut.
2. Attach the mounting strap to the outlet box by using two mounting screws.
3. Secure the top loop to the set nipple.
4. Attach the loop to the set nipple of the fixture.
5. Adjust the arms of the fixture according to the drawing of the package. Then fix them to the metal ring by using the set screws.

Important:

a. The arms should be positioned with equal distance between them.

b. The arms should be fixed securely.

6. Choose the length of the chain you need, then weave the fixture wire and the fixture grounding wire through the chain, collar and canopy.
7. Connect one end of the chain with the loop by using a loop lock.
8. Connect the other end of the chain with the top loop by using another loop lock.
9. Thread the fixture wire and fixture grounding wire through the top loop, nipple and mounting strap.
10. Pull out the outlet wires and house grounding wire from the outlet box. Make wire connections using the wire nuts:
 - The smooth wire (marked) from the fixture to the black wire from the power source.
 - The ridged wire (unmarked) from the fixture to the white wire from the power source.
 - Attach the fixture grounding wire to the mounting strap with the green grounding screw. Then connect it to the house grounding wire with a wire nut.
 Carefully put the wires back into the outlet box.
11. Attach the canopy to the mounting strap by inserting the top loop, then secure it with the collar.
12. Attach the glass shades to the glass holders, then secure them with the spacers and socket rings.
13. Install bulbs (not included). See relamping label at socket area or packaging for maximum allowed wattage.
14. Turn on the power at the main fuse or circuit breaker box.