

Important: Label on back contains important information on your crystal option. Please save in case you ever need to order matching crystal.

Trim Diagram
Refrax™ Pendant RE0209-**

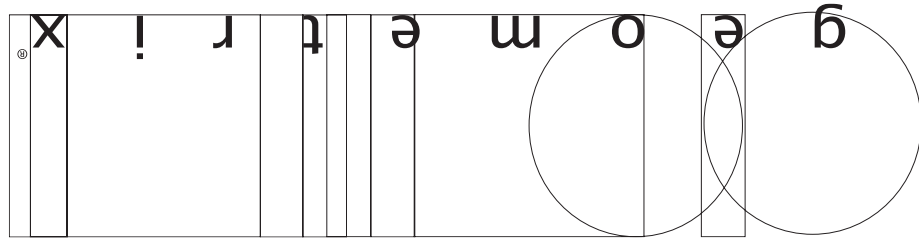

Schonbek Worldwide Lighting Inc., 61 Industrial Blvd., Plattsburgh NY 12901-1908
Tel: 800.836.1892 or 518.563.7500 www.schonbek.com

© 2006 SCHONBEK WORLDWIDE LIGHTING INC., A. SCHONBEK & CO. LTD. WORLDWIDE COPYRIGHT RESERVED

US PATENT: #5,109,325

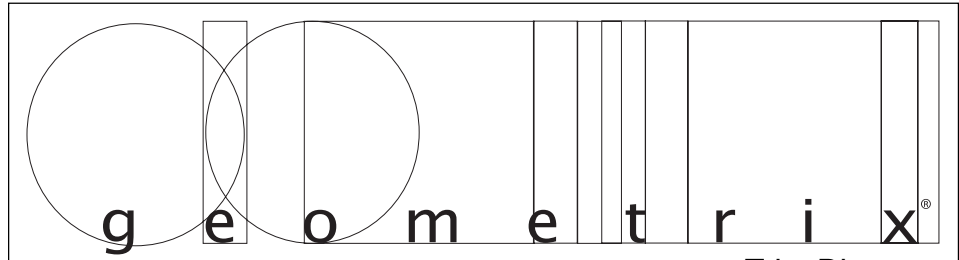

Trim Diagram
Refrax™ Pendant RE0209-**

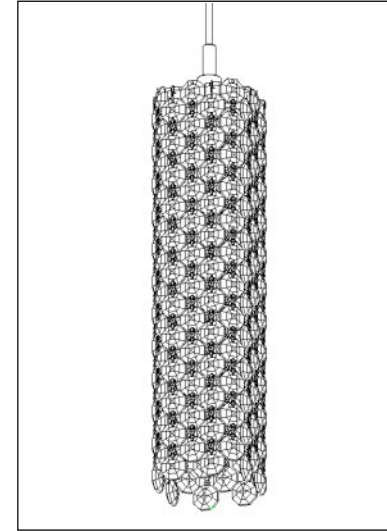

1 Light
Length: 2", Width: 2", Height: 9"

Geometrix™ is designed by Schonbek with Strass® crystal by Swarovski.



This design is the proprietary trade dress/trademark of Schonbek Worldwide Lighting Inc

Please save your trim diagram for future reference.

IMPORTANT: Label on back contains important information on your crystal option. Please save in case you ever need to order matching crystal.



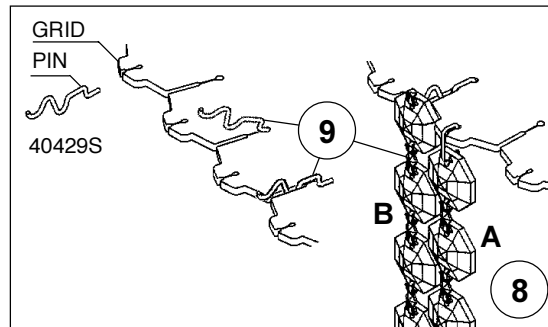
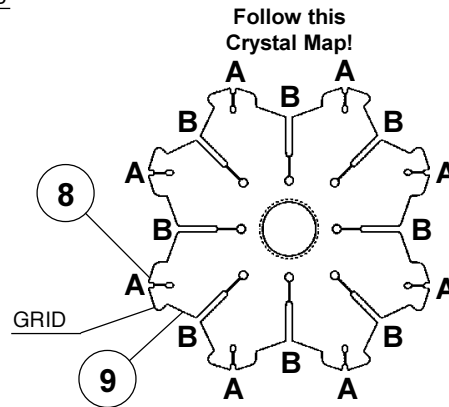
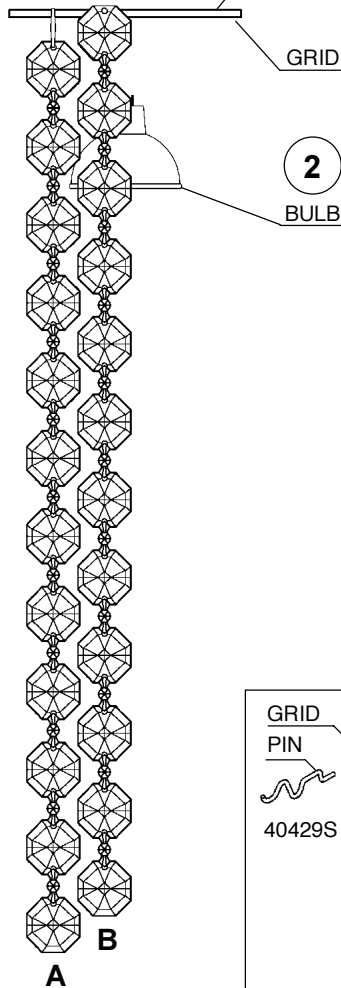
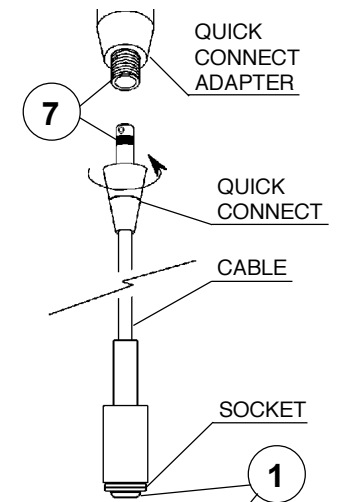
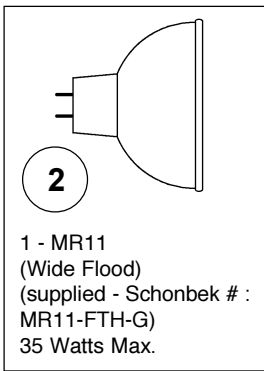

How to Install Mr11 Bulb and Refrax™ Pendant

Pendants may be mounted to monorail systems, monopoints or line voltage track by coupling to the quick connect transformer adapter. Attached to the socket is a cable that may be cut on site during installation to any length (see instructions below).

1 Position the pendant grid against the socket and secure in place by screwing the metal collar onto the socket.

2 Plug bulb carefully but completely into socket. Use only an MR11 glass covered lamp bulb.

How to Shorten the Cable:

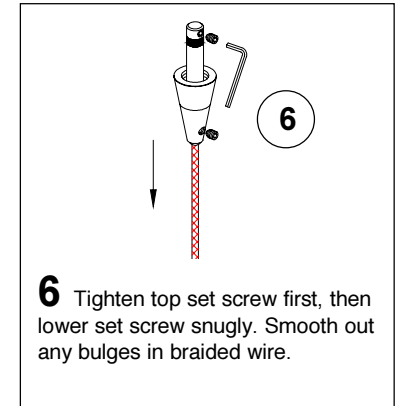
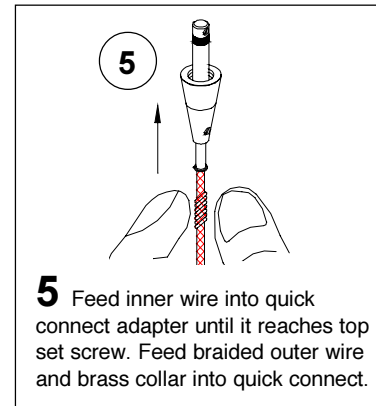
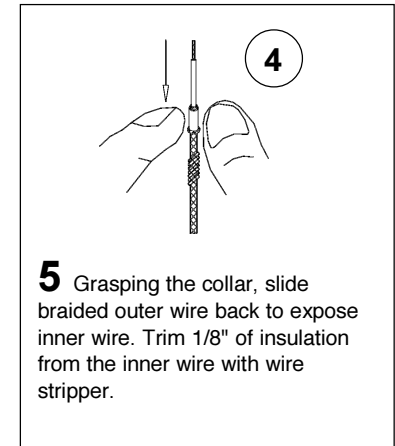
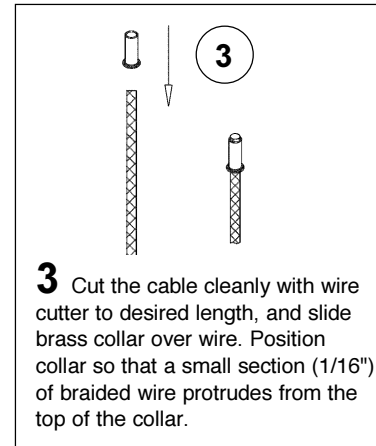

7 Screw quick connect into quick connect adapter until it seats. If you adjust the orientation of the pendant, be careful not to loosen the connection.

8 Hang A chains first, following the crystal map. Hook the connectors into the pinholes located towards the outside of the grid. See illustration to the left.

9 Insert pins into grid. Hang B chains by sliding the octagon with an open hole onto the pin. Chains B will nest into position between A chains. See illustration to the left.