

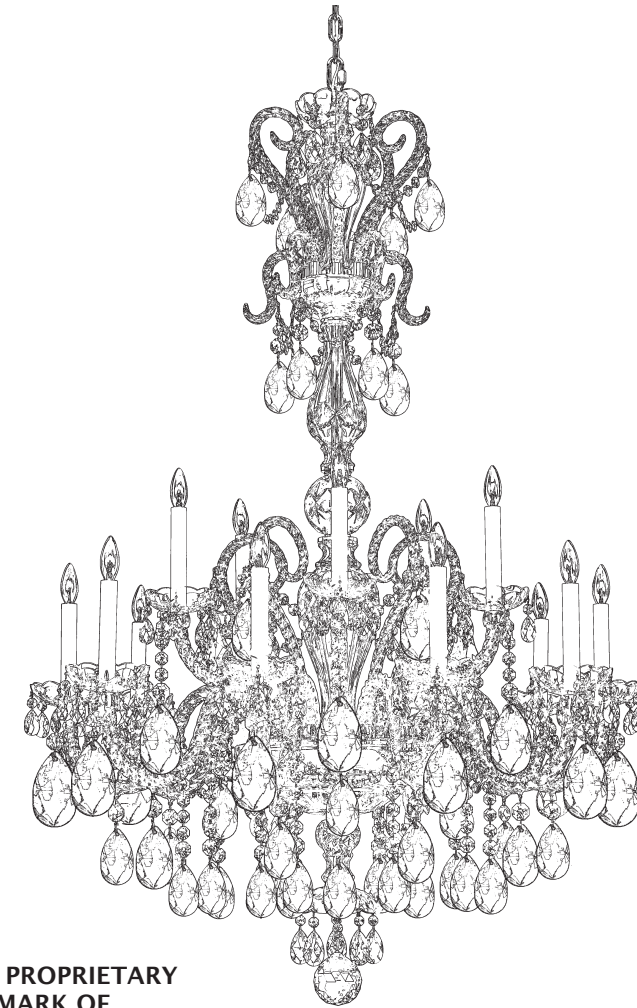

SCHONBEK®

NOVIELLE NV3915- ____ A TRIM DIAGRAM

(Finish Option)



15 + 5 Lights
Diameter: 35"
Body Length: 55"
Hanging Weight: 76lbs.

THIS DESIGN IS THE PROPRIETARY TRADE DRESS/TRADEMARK OF SCHONBEK WORLDWIDE LIGHTING INC.



SCHONBEK®



MAX 60 W

110-120 V

1

IMPORTANT

Person who opens carton should record the following information for future service.

CODE # _____ Four-digit number on outside of carton.

PACKER # _____ See crystal package label.

ORDER # _____ See crystal package label.

SCHONBEK® is a member of the Swarovski company.

Instructions for electrician STEPS 2 - 7

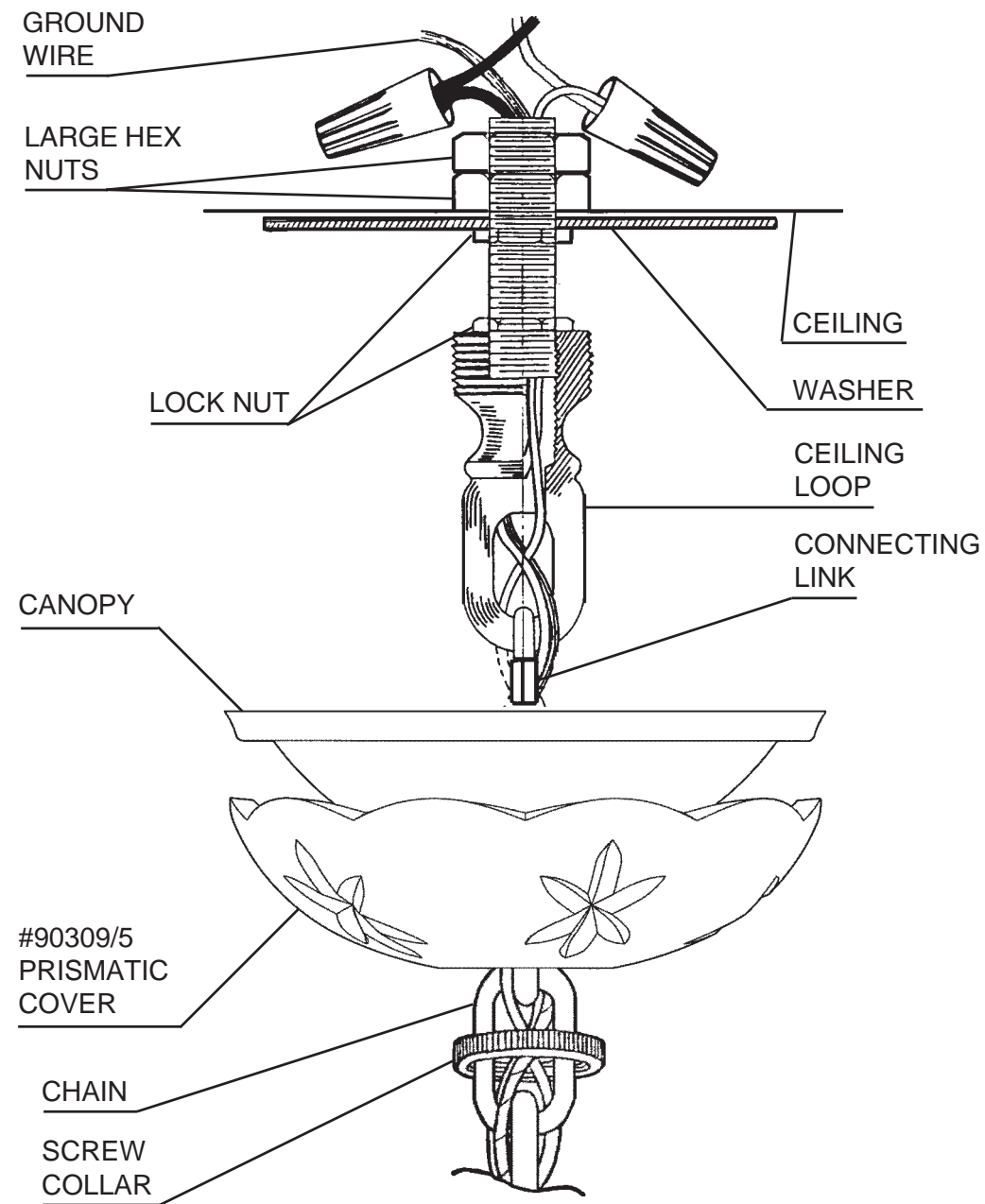

2 MAKE SURE POWER IS DISCONNECTED!!

3 Attach washer to supporting member in ceiling sufficient to support weight of fixture.

4 Slip screw collar, prismatic cover and metal canopy over chain. Determine the suspension length of the fixture and cut chain, if necessary. Use two connecting links to attach chain to chandelier loop and ceiling loop.

5 Insert stem wire through chain and ceiling loop. Connect wires. Fixture MUST be grounded.

6 Check distance from ceiling to loop to assure canopy assembly will be flush against ceiling.

7 Attach canopy to ceiling with screw collar.

NOTES:

FRAGILE:

CAUTION: Glass parts are fragile. To avoid breakage use care when assembling or cleaning.

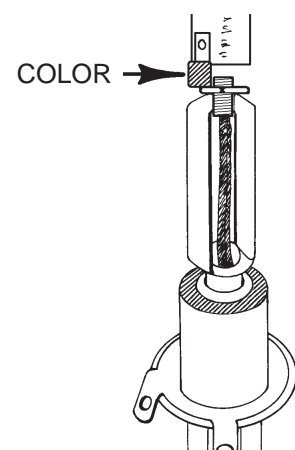

WHEN ORDERING REPLACEMENT ARM(S):

- ** Give arm number from trim diagram
- ** Give color code from the arm itself

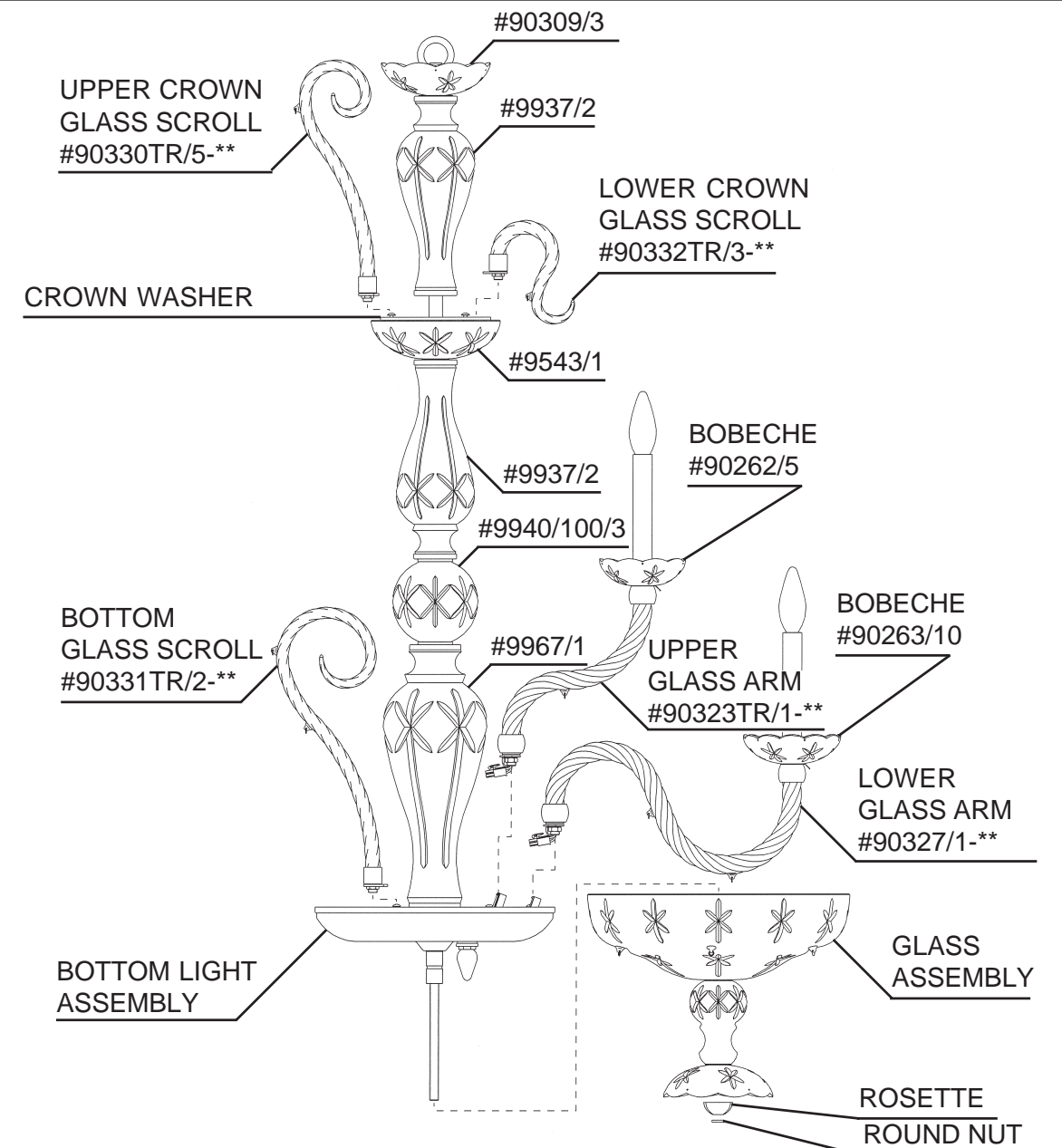

8 Install lower crown scrolls into inner hole pattern and upper crown scrolls into outer hole pattern of the crown washer. Use screws to secure scroll in place.

9 Install bottom scrolls into inner hole pattern of bottom washer. NOTE: Upper glass arms go into inner hole pattern of the bottom washer that have the plug-in connections and the lower glass arms go into the outer hole pattern. Connect arm wires to the center column using plug-in connectors. See detailed illustration.

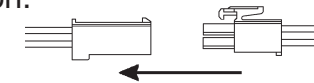

10 Push wires into hole and attach arm to washer by rotating arm into place. NOTE: Alternate installing upper and lower glass arms. Lock down by tightening screws into flange. See detailed illustration. Attach glass assembly with rosette and round nut provided.

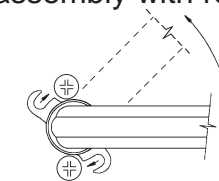

11 Install (5) C7 light bulbs (supplied) into bottom light assembly. Attach glass assembly with rosette and round nut. Install bobeches and bulbs. Connect power and test fixture before trimming. If any of the bulbs do NOT light - DISCONNECT POWER. Double check the wire connections.

Instructions for crystal trimming STEPS 12 - 32

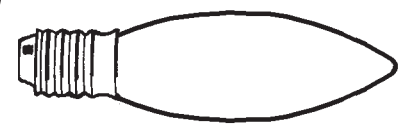

You will need 15 - B10
25 Watts Recommended
60 Watts Max

12

You will need 5 - C7
(Supplied)
7-1/2 Watts Max

**Install bulbs and be
sure to test fixture
BEFORE trimming.**

