

Instructions for electrician
STEPS 2 - 18

WARNING:

2

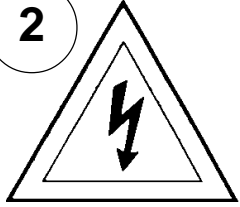

Electrical Danger

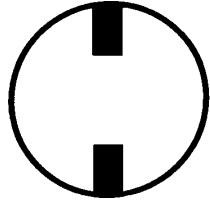

Turn Power Off

All electrical components must be installed by a licensed electrician in accordance with the National Electric Code and the appropriate local electrical codes.

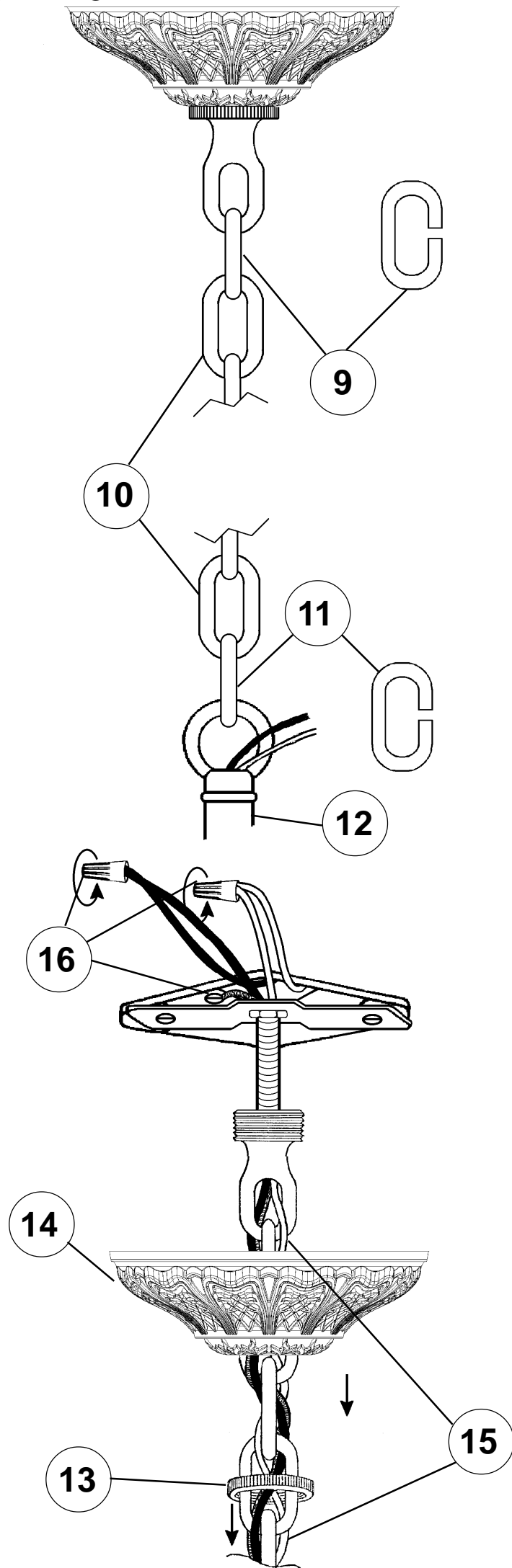
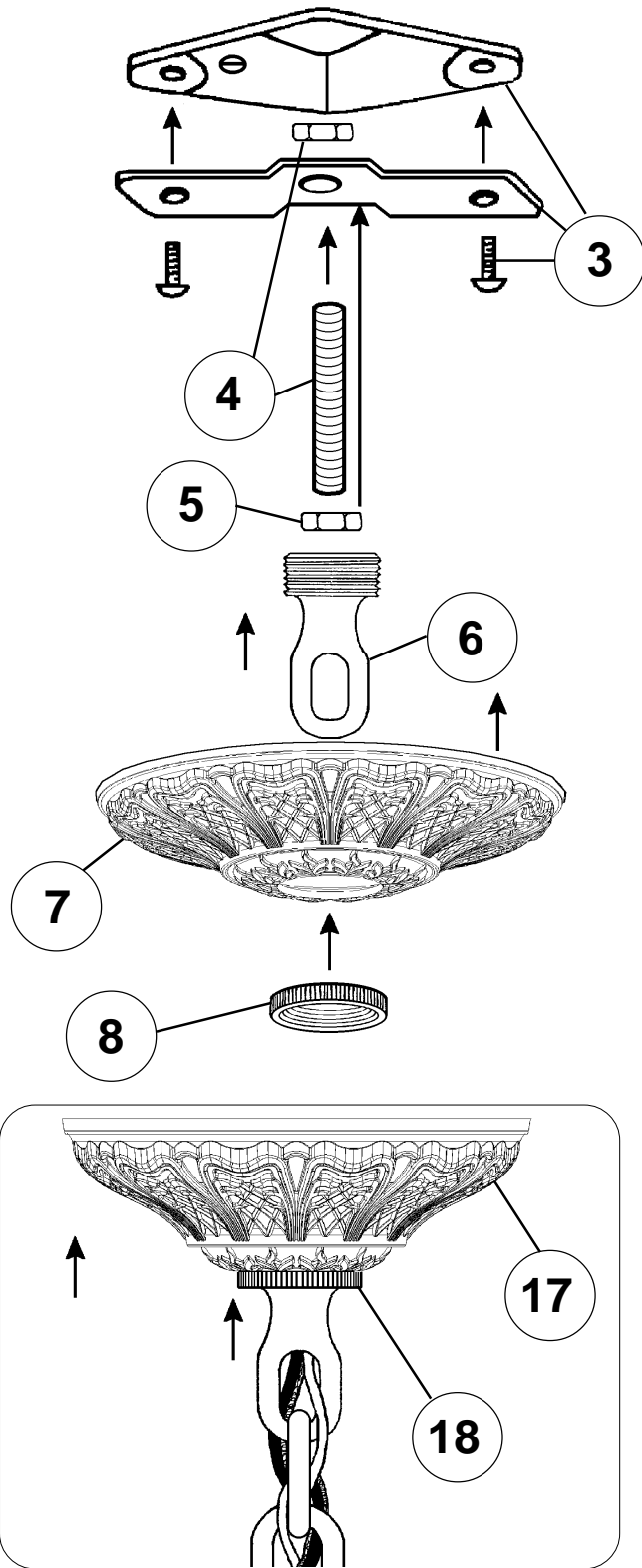

CHANDELIER 5679- _____ A TRIM DIAGRAM

(Finish Option)

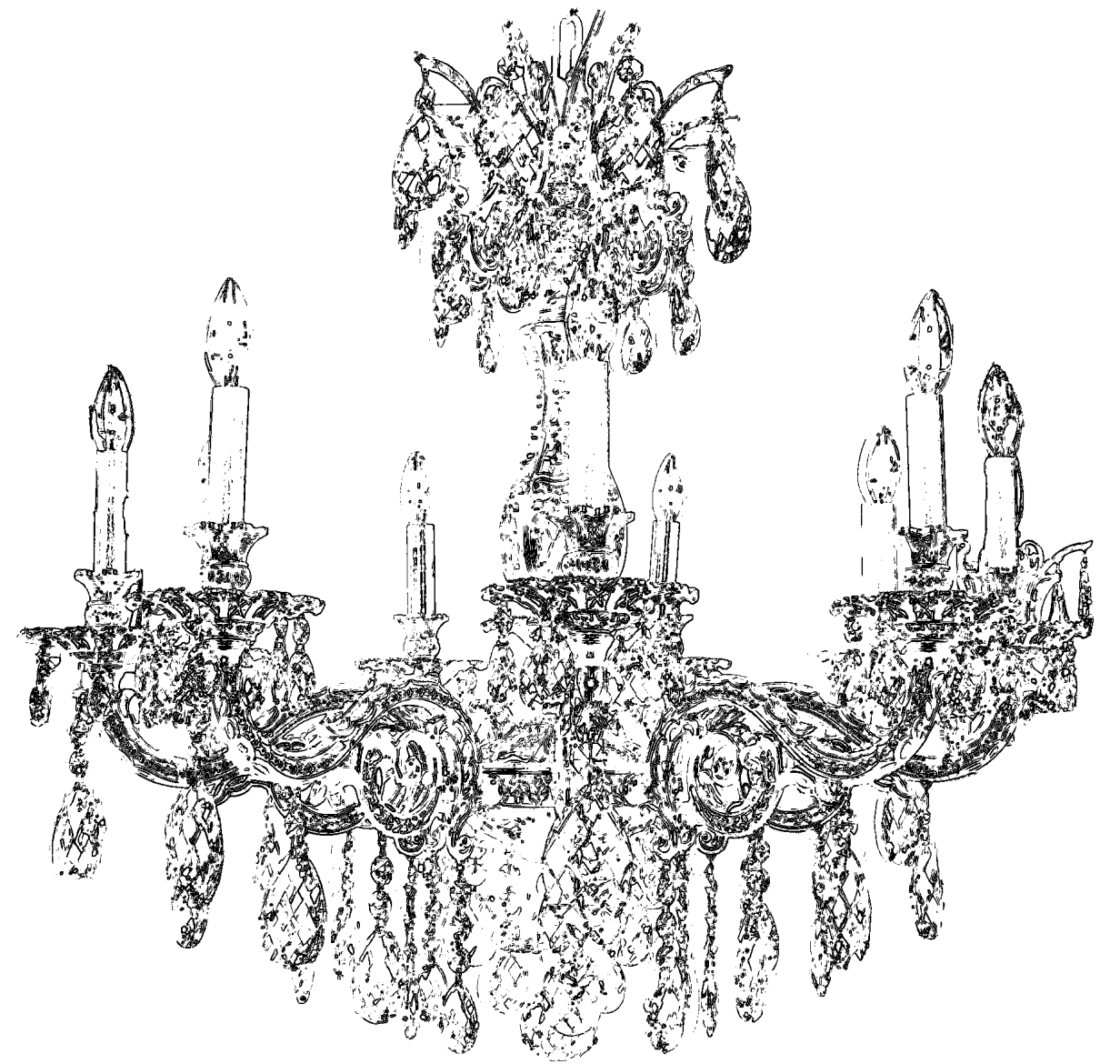

T HIS DESIGN IS THE PROPRIETARY TRADE DRESS / TRADE MARK OF SCHONBEK WORLDWIDE LIGHTING INC.

9 Lights
Diameter: 30"
Body Length: 31"
Hanging Weight: 30 lbs.

SCHONBEK®

See diagram on back page
Follow steps in exact order
Save this trim diagram for future reference

1 **IMPORTANT**
Person who opens carton should record the following information for future service.
CODE # _____ Four-digit number on outside of carton.
PACKER # _____ See crystal package label.
ORDER # _____ See crystal package label.

Instructions for crystal trimming

STEPS 19 - 29

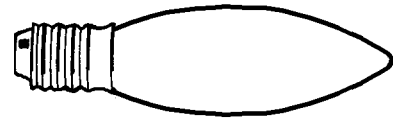

You will need 9 - C10
25 Watts Recommended
60 Watts Max

19

Install bulbs and be
sure to test fixture
BEFORE trimming.

DIAGRAM #1

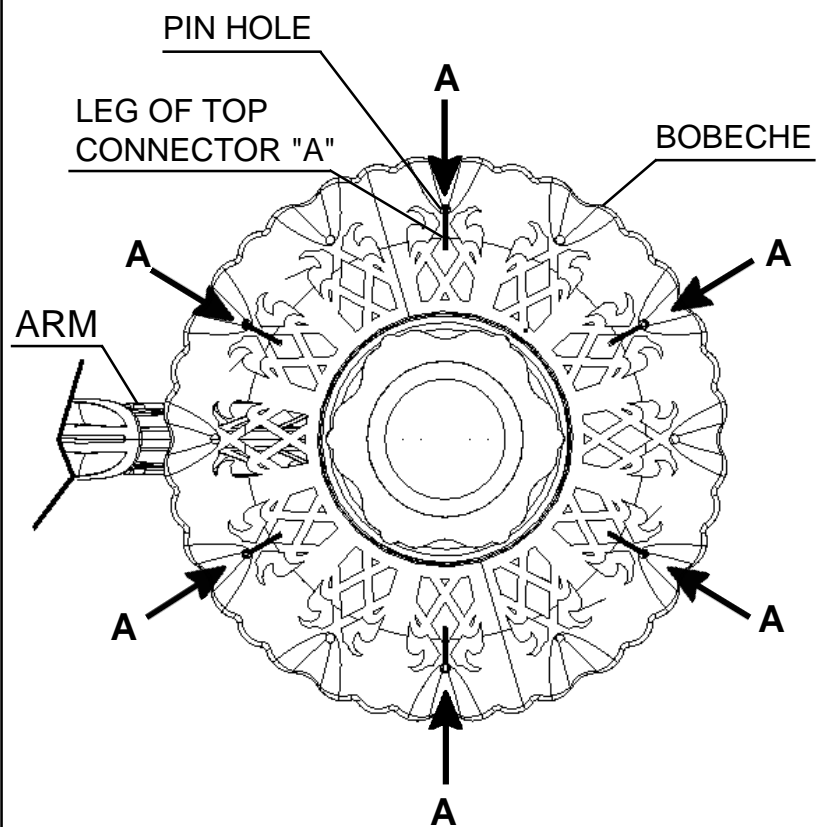

When trimming bobèche with letter "A", insert leg of top connector into pin hole from under bobèche. Hang in every other pin hole starting on either side of the arm (refer to Diagram #1)



Tighten With
Tool Provided.

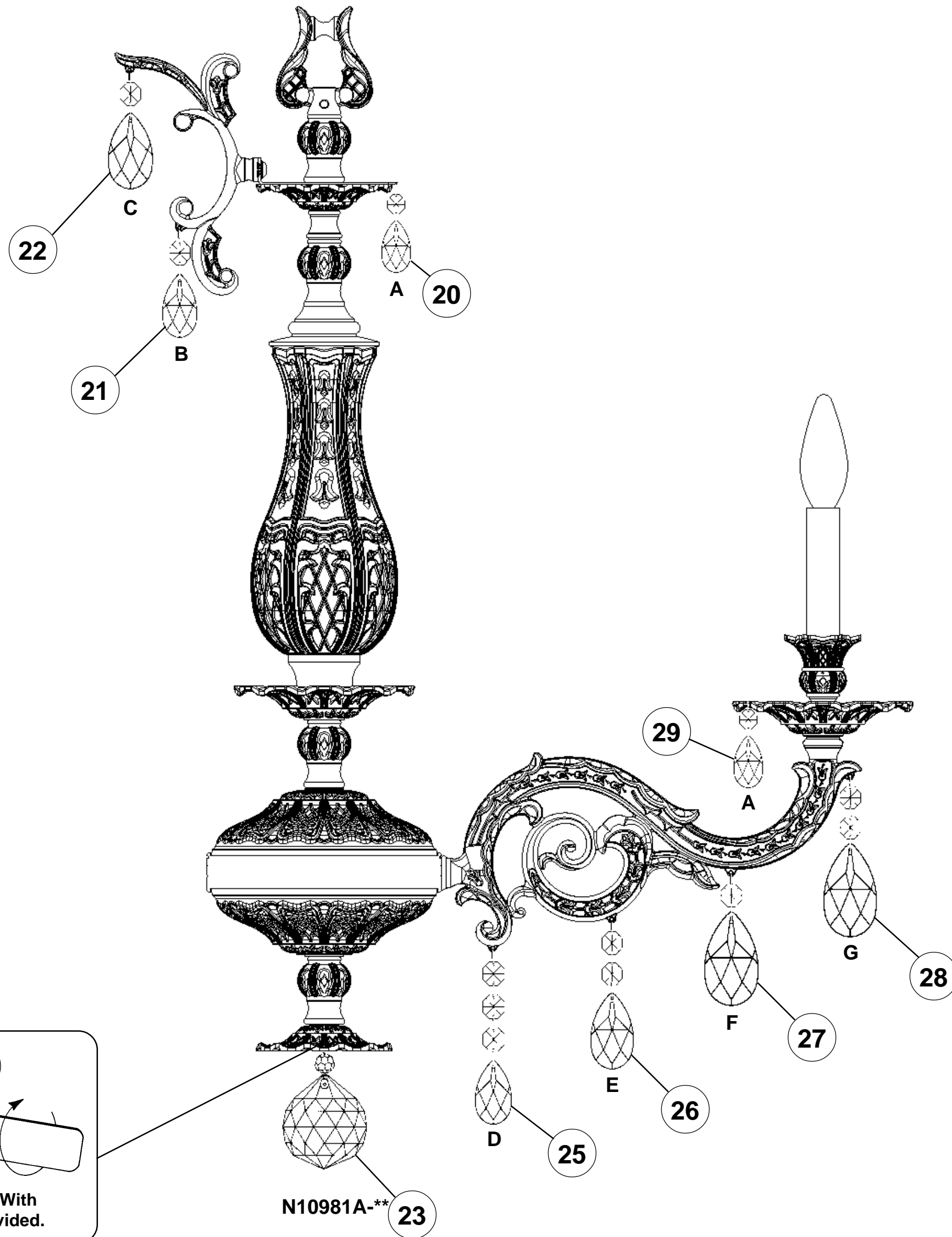

N10981A-** 23

