

# SCHONBEK®

## CHANDELIER 3787- \_\_\_\_\_ TRIM DIAGRAM

(Finish Option) (Trim Option)

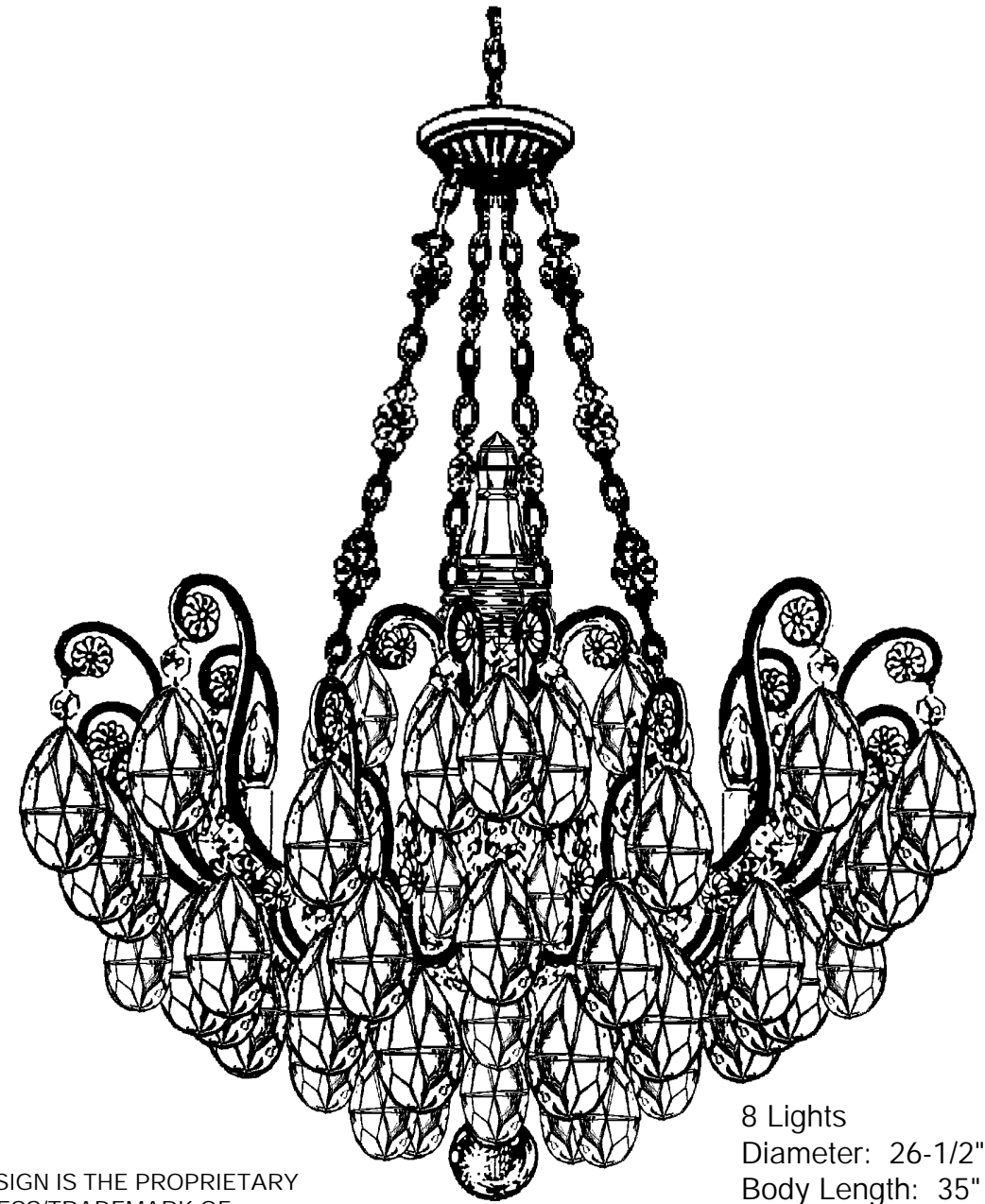

THIS DESIGN IS THE PROPRIETARY  
TRADE DRESS/TRADEMARK OF  
SCHONBEK WORLDWIDE LIGHTING INC.

8 Lights  
Diameter: 26-1/2"  
Body Length: 35"  
Hanging Weight: 37 lbs.

# SCHONBEK®

Follow steps in exact order  
Save this trim diagram for future reference

1

### IMPORTANT

Person who opens carton should record the following information for future service.

CODE # \_\_\_\_\_ Four-digit number on outside of carton.  
PACKER # \_\_\_\_\_ See crystal package label.  
ORDER # \_\_\_\_\_ See crystal package label.

SCHONBEK IS A WORLD LEADER IN CHANDELIER DESIGN. PATENTS INCLUDE:  
#D335,362

Instructions for electrician  
STEPS 2 - 21

**WARNING:**

2  
Electrical Danger Turn Power Off

All electrical components must be installed by a licensed electrician in accordance with the National Electric Code and the appropriate local electrical codes.

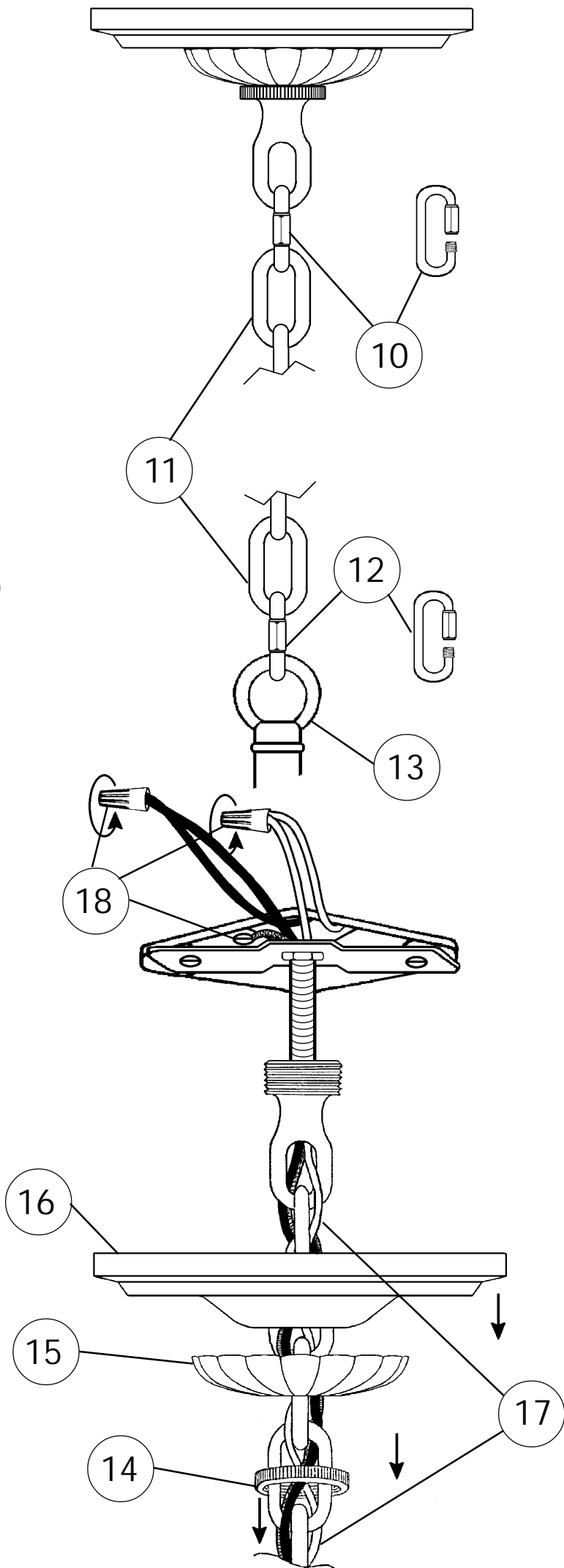
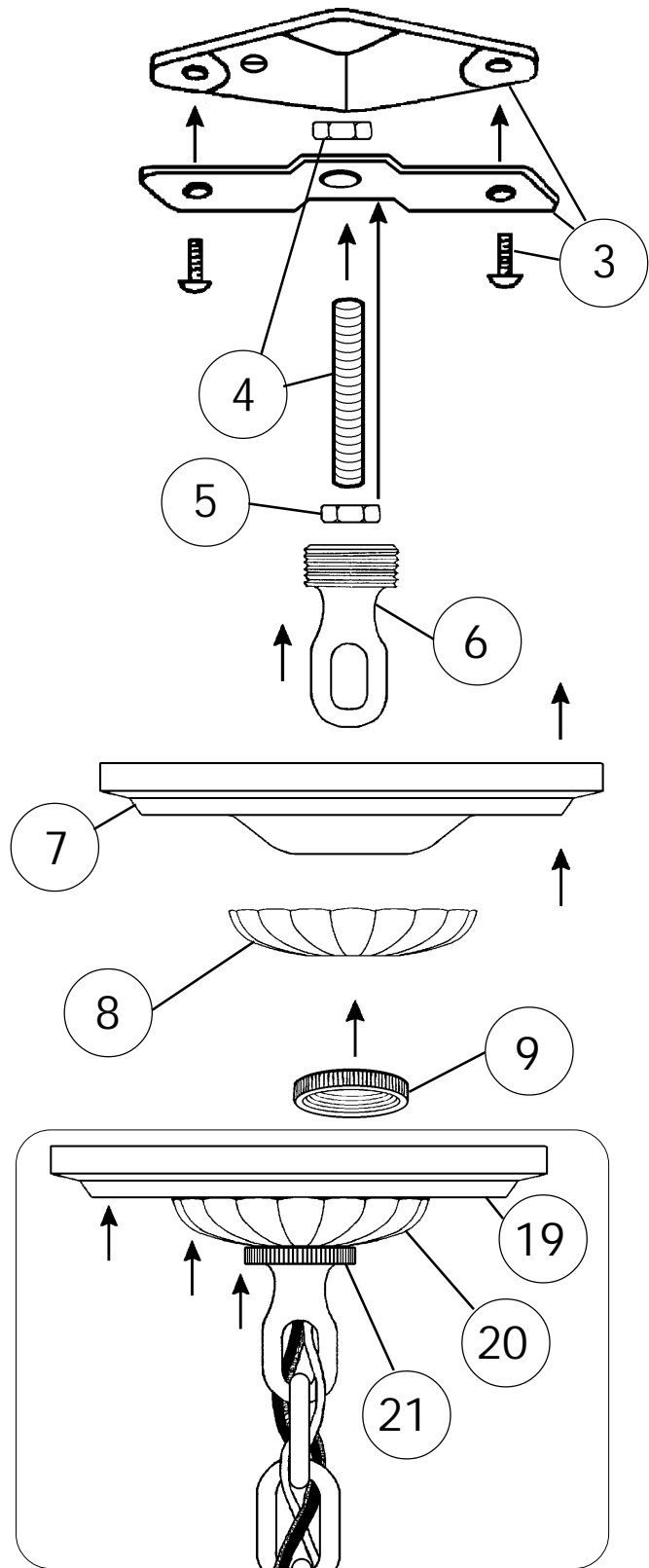

SET #1

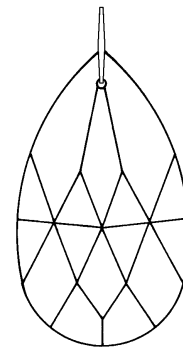

N4014-\*\*  
2-1/2"  
63mm

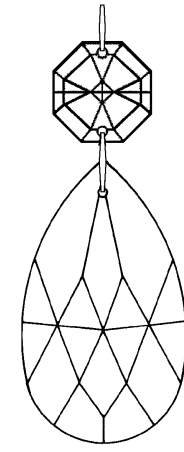

N4003-\*\*  
2-1/2"  
63mm

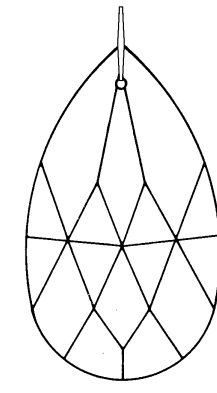

N4004-\*\*  
3"  
76mm

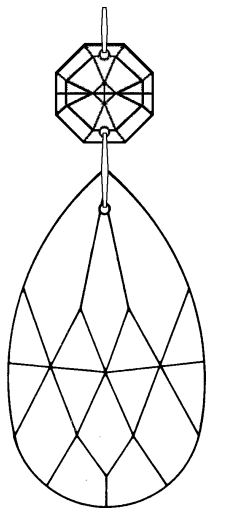

N4000-\*\*  
3"  
76mm

SET #2

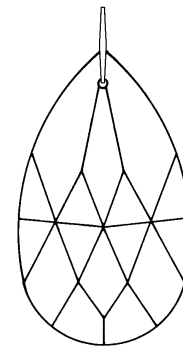

N4014-\*\*  
2-1/2"  
63mm

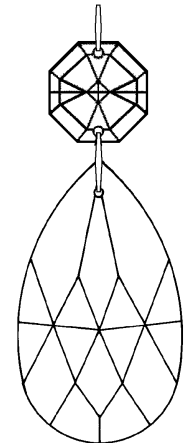

N4003-\*\*  
2-1/2"  
63mm

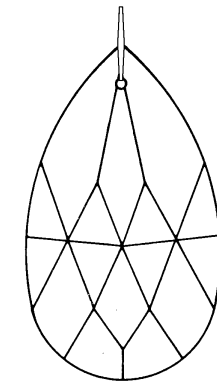

N4004-\*\*  
3"  
76mm

SET #3

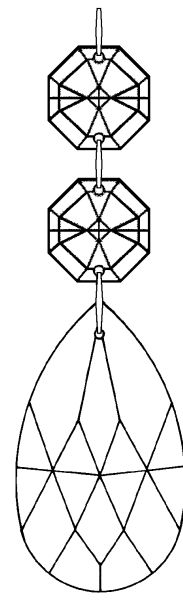

N4015-\*\*  
2-1/2"  
63mm

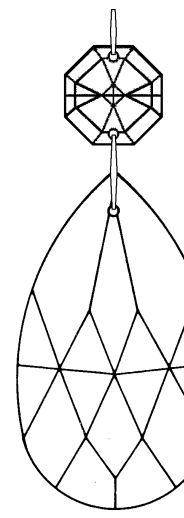

N4000-\*\*  
3"  
76mm

Crystal Set #3 in Black

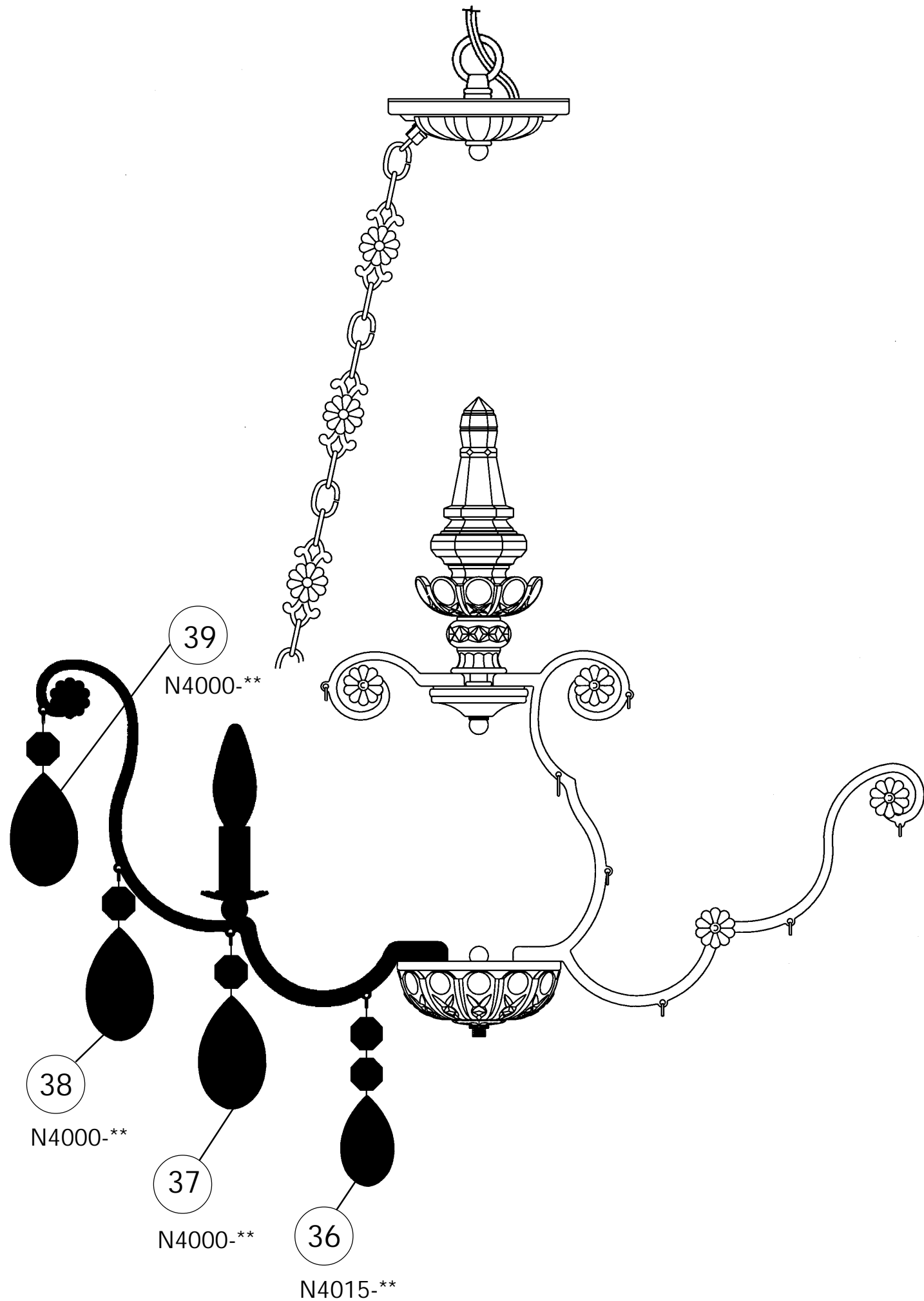

For easy removal of crystal from bubble pack, please cut along pouches on the inside of the seam. Gently remove crystal from the side of the pouch.

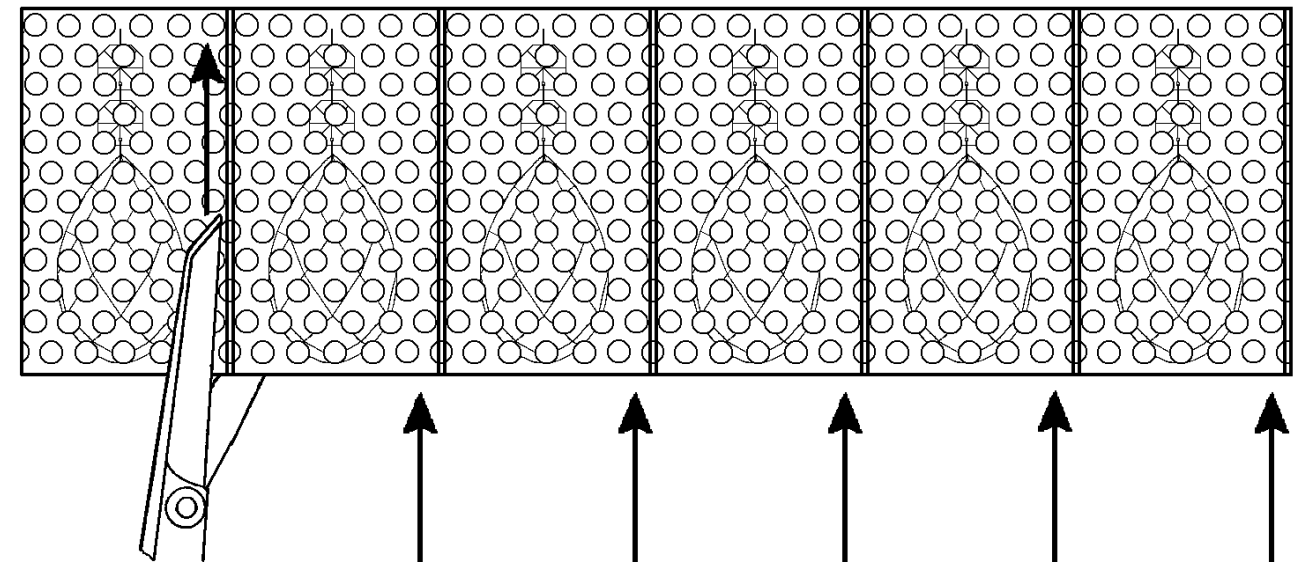

**NOTE:** Work on one crystal set at a time. Follow the black line from top to bottom according to the numbered steps on the trim diagram.

Instructions for crystal trimming  
STEPS 22 - 39

FIXTURE INCLUDES:  
Hanger Hardware  
Trim  
Frame  
DOES NOT INCLUDE:  
C10 - Light Bulbs

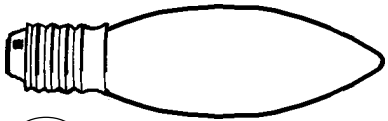

**22**

You will need 8 - C10  
25 Watts Recommended  
60 Watts Max

Install bulb and be sure  
to test fixture BEFORE  
trimming.

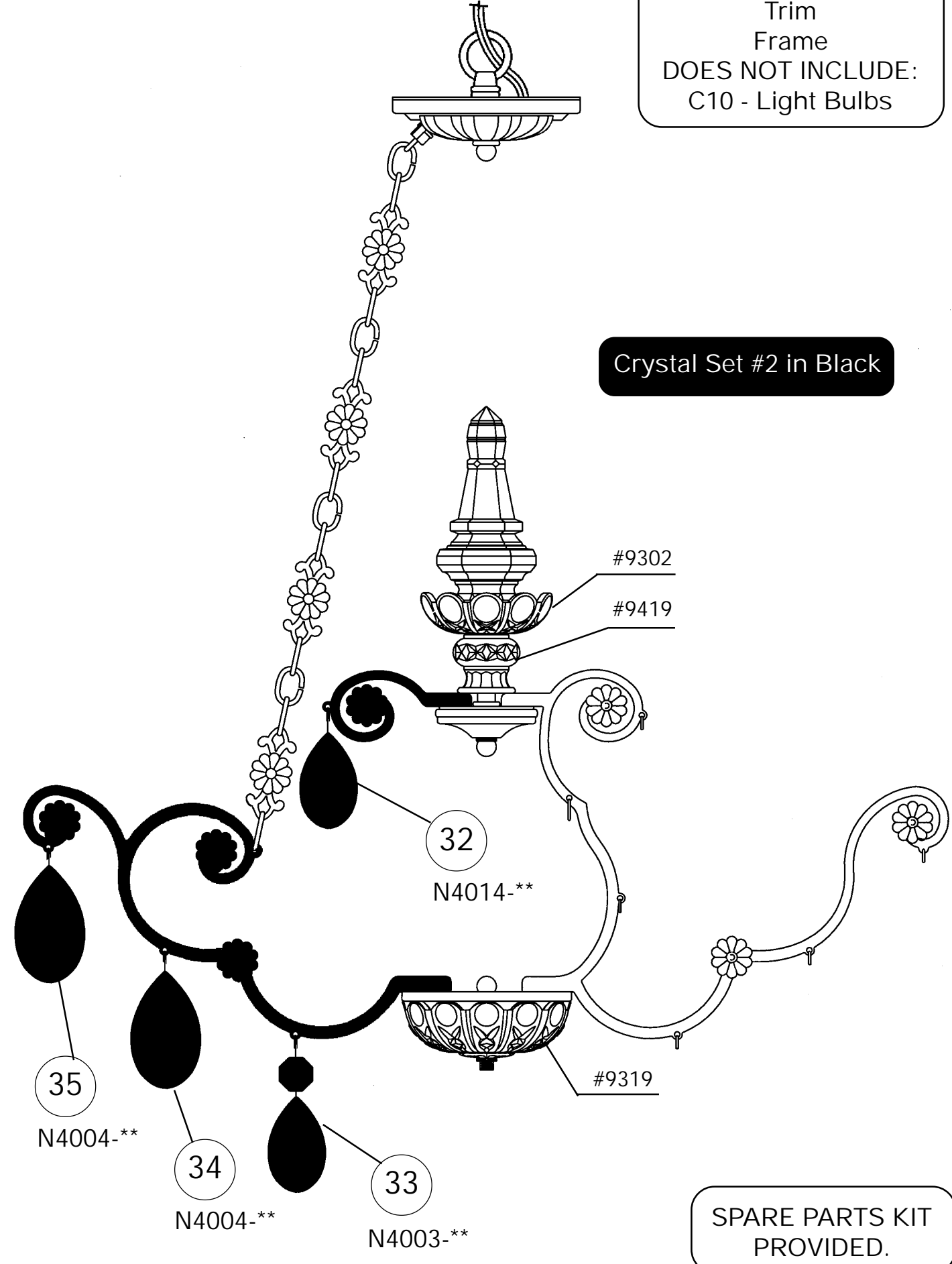
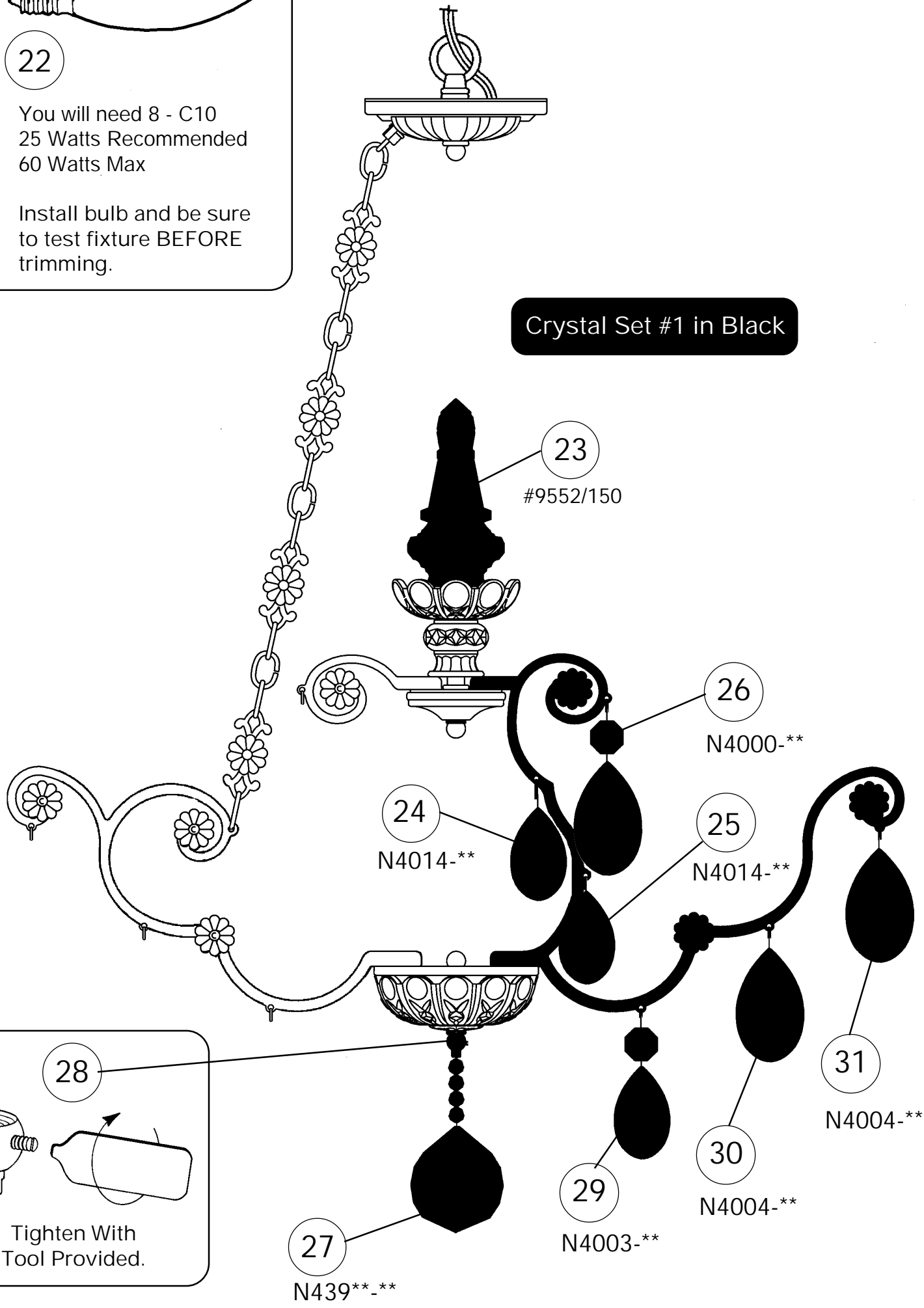

SPARE PARTS KIT  
PROVIDED.

