

SCHONBEK®

CHANDELIER 3782- _____ TRIM DIAGRAM

(Finish Option) (Trim Option)

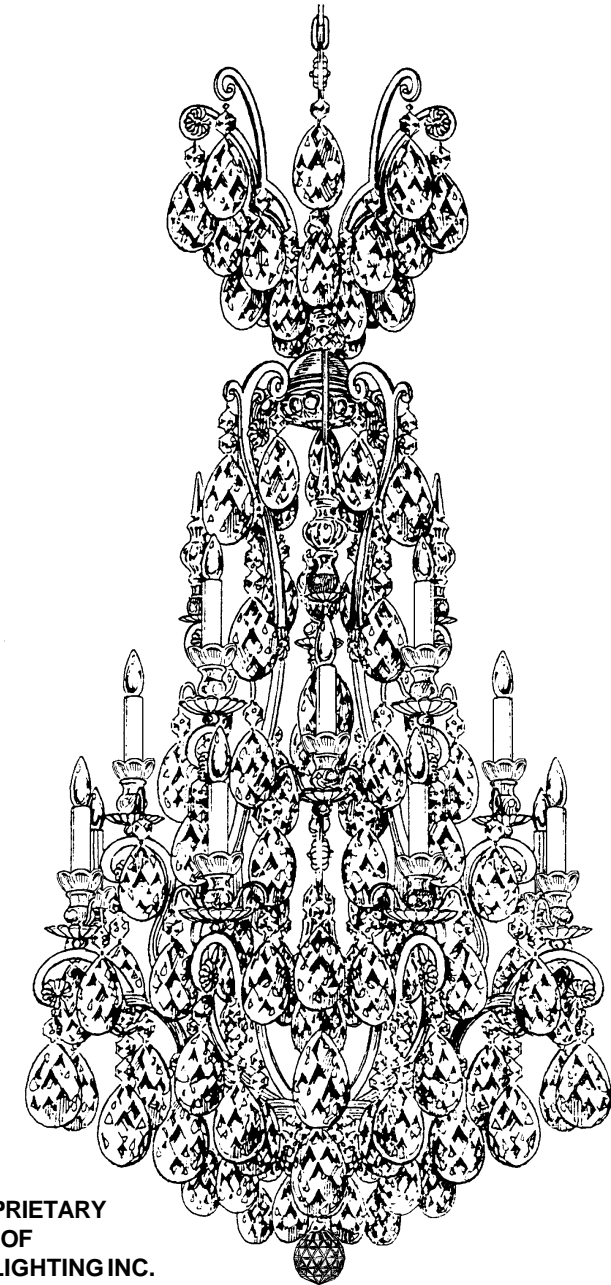

THIS DESIGN IS THE PROPRIETARY TRADE DRESS/TRADE MARK OF SCHONBEK WORLDWIDE LIGHTING INC.

16 + 1 Lights
Diameter: 28"
Body Length: 56-1/2"
Hanging Weight: 74 lbs.

SCHONBEK®

**Follow steps in exact order
Save this trim diagram for future reference**

1

IMPORTANT

Person who opens carton should record the following information for future service.

CODE # _____ Four-digit number on outside of carton.
PACKER # _____ See crystal package label.
ORDER # _____ See crystal package label.

SCHONBEK IS A WORLD LEADER IN CHANDELIER DESIGN. PATENTS INCLUDE:
#D5,222,805

Instructions for electrician

STEPS 2 - 21

WARNING: THIS LUMINAIRE MUST BE MOUNTED OR SUPPORTED INDEPENDENTLY OF AN OUTLET BOX.

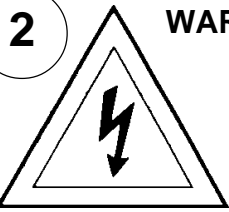
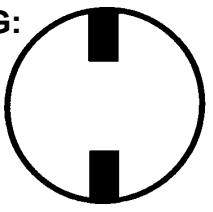
2 **WARNING:**  

Electrical Danger Turn Power Off

All electrical components must be installed by a licensed electrician in accordance with the National Electric Code and the appropriate local electrical codes.

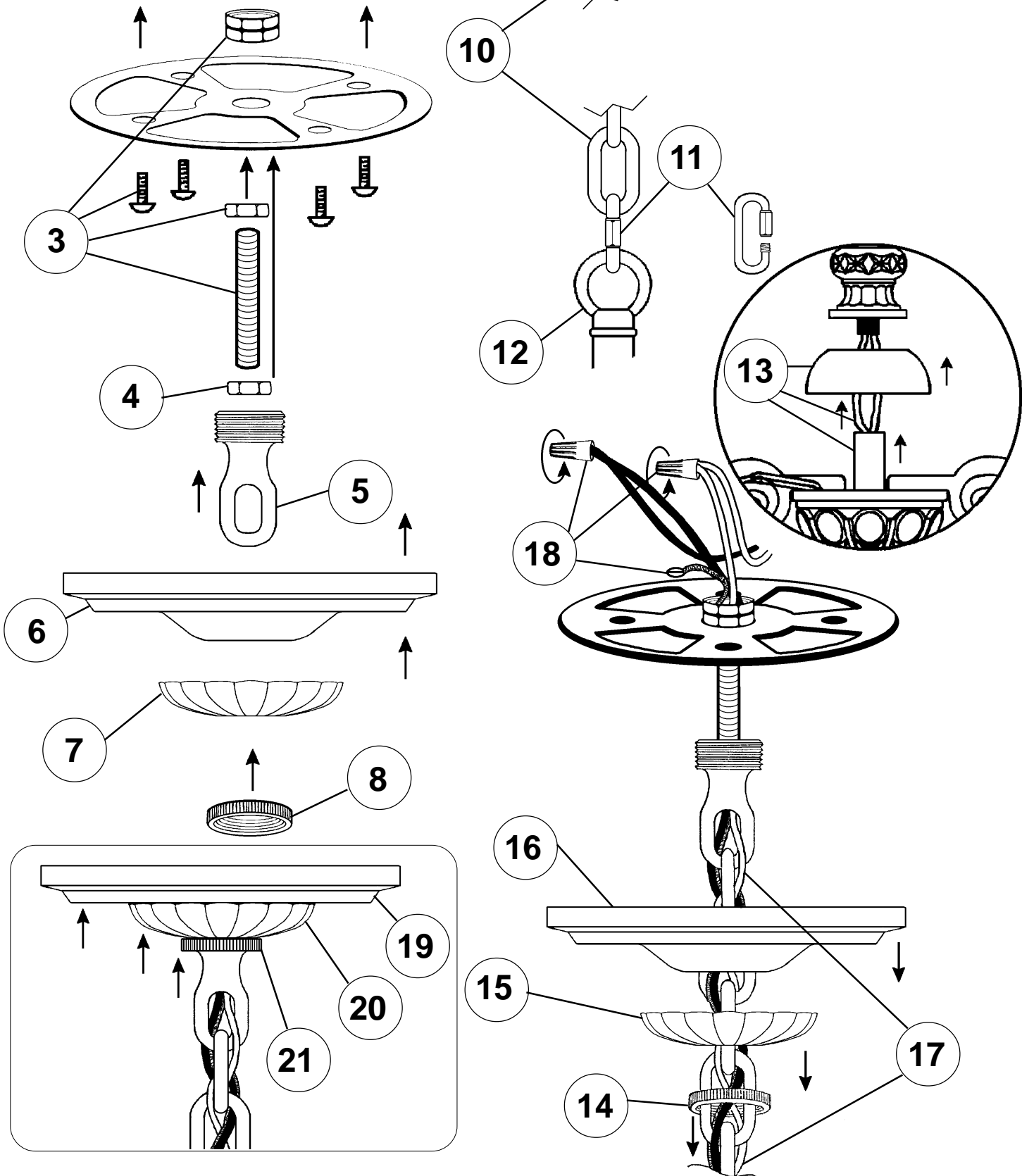

SET #1

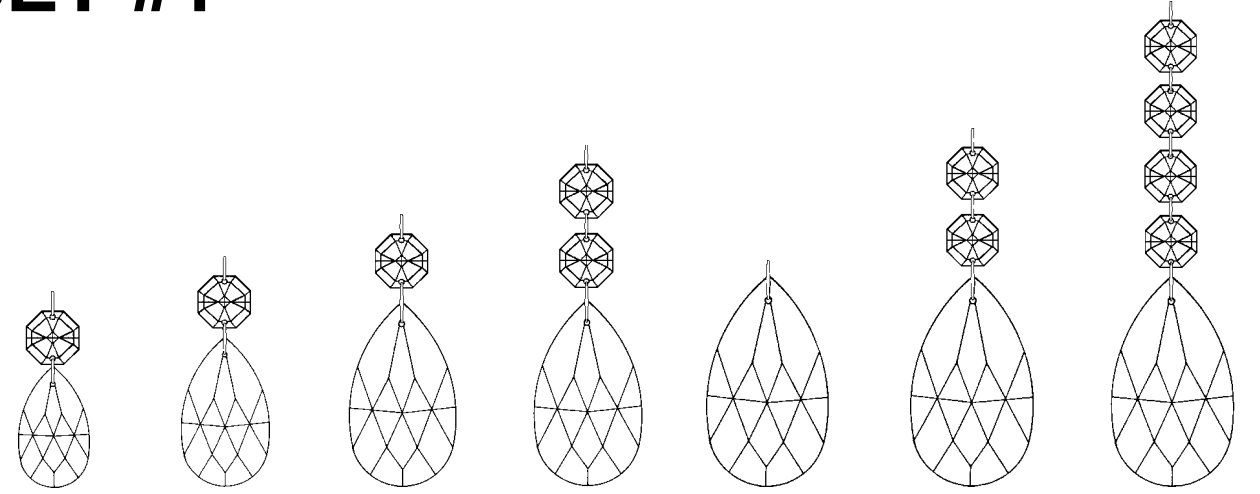

- | | | | | | | |
|-------------------------------|-----------------------------------|-------------------------------|-------------------------------|-----------------------------------|-----------------------------------|-----------------------------------|
| N4044-**
2"
50mm | N4003-**
2-1/2"
63mm | N4000-**
3"
76mm | N4010-**
3"
76mm | N4001-**
3-1/2"
89mm | N4002-**
3-1/2"
89mm | N4040-**
3-1/2"
89mm |
|-------------------------------|-----------------------------------|-------------------------------|-------------------------------|-----------------------------------|-----------------------------------|-----------------------------------|

SET #2

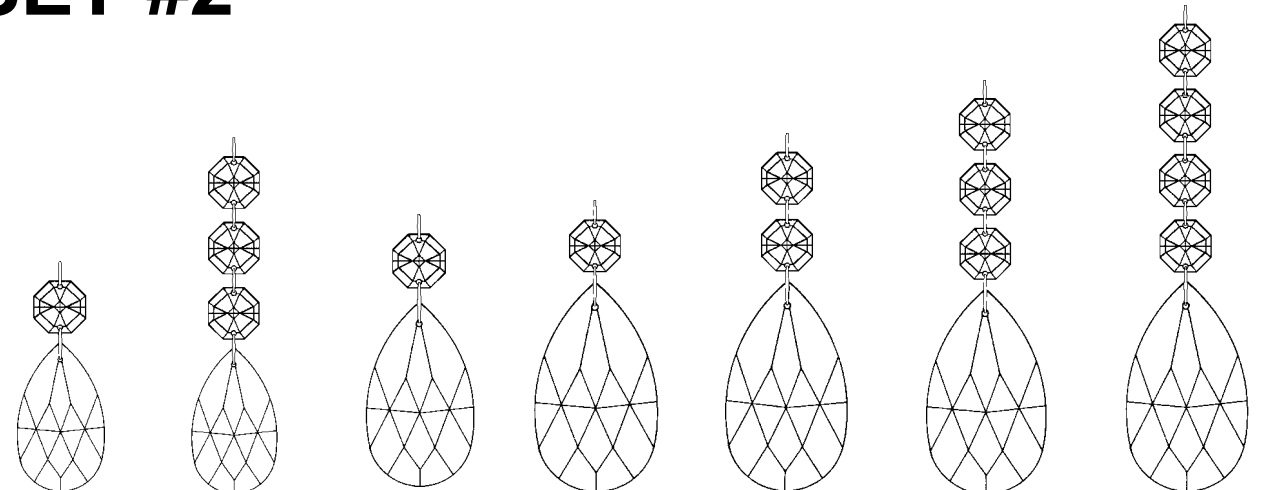

- | | | | | | | |
|-----------------------------------|-----------------------------------|-------------------------------|-----------------------------------|-----------------------------------|-----------------------------------|-----------------------------------|
| N4003-**
2-1/2"
63mm | N4017-**
2-1/2"
63mm | N4000-**
3"
76mm | N4007-**
3-1/2"
89mm | N4002-**
3-1/2"
89mm | N4019-**
3-1/2"
89mm | N4040-**
3-1/2"
89mm |
|-----------------------------------|-----------------------------------|-------------------------------|-----------------------------------|-----------------------------------|-----------------------------------|-----------------------------------|

SET #3

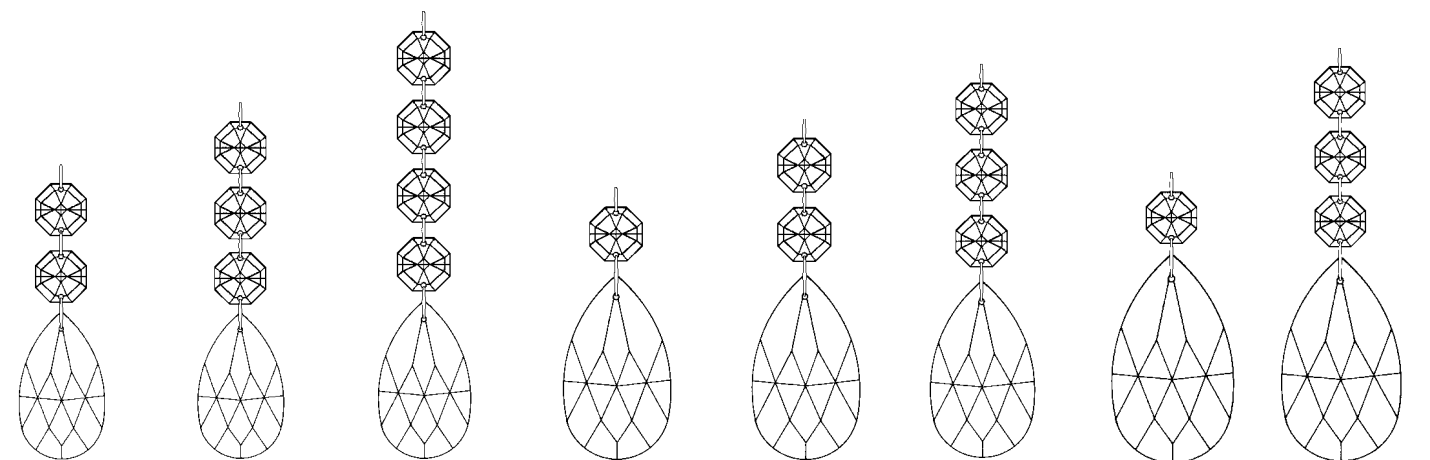

- | | | | | | | | |
|-----------------------------------|-----------------------------------|-----------------------------------|-------------------------------|-------------------------------|-------------------------------|-----------------------------------|-----------------------------------|
| N4015-**
2-1/2"
63mm | N4017-**
2-1/2"
63mm | N4018-**
2-1/2"
63mm | N4000-**
3"
76mm | N4010-**
3"
76mm | N4020-**
3"
76mm | N4007-**
3-1/2"
89mm | N4019-**
3-1/2"
89mm |
|-----------------------------------|-----------------------------------|-----------------------------------|-------------------------------|-------------------------------|-------------------------------|-----------------------------------|-----------------------------------|

Crystal Set #3 in Black

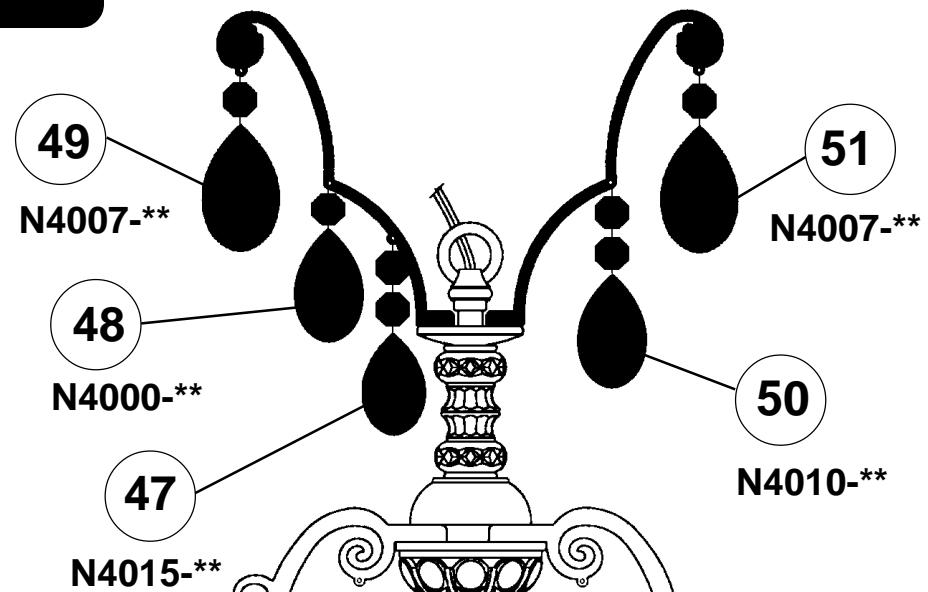

SPARE PARTS KIT PROVIDED.

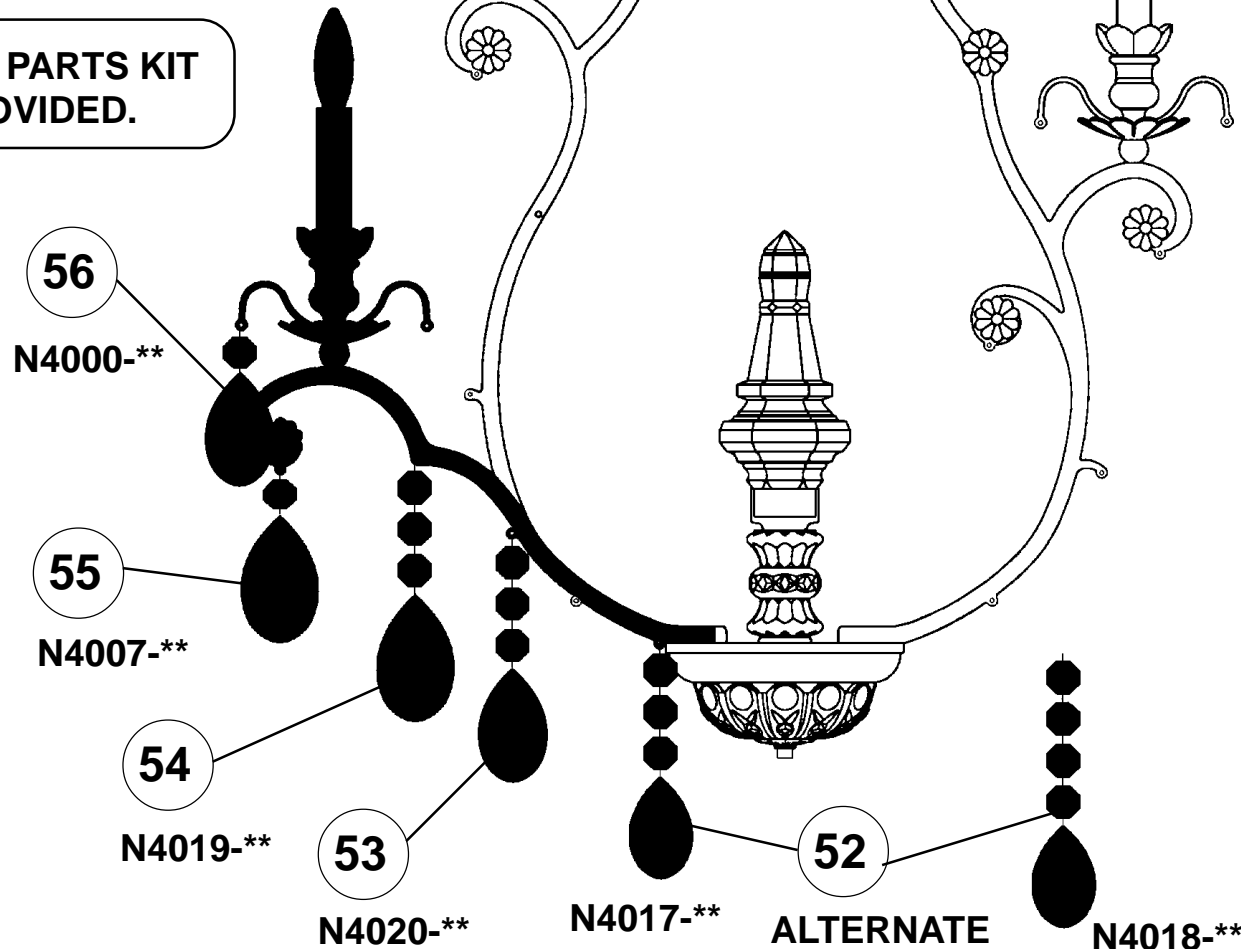

For easy removal of crystal from bubble pack, please cut along pouches on the inside of the seam. Gently remove crystal from the side of the pouch.

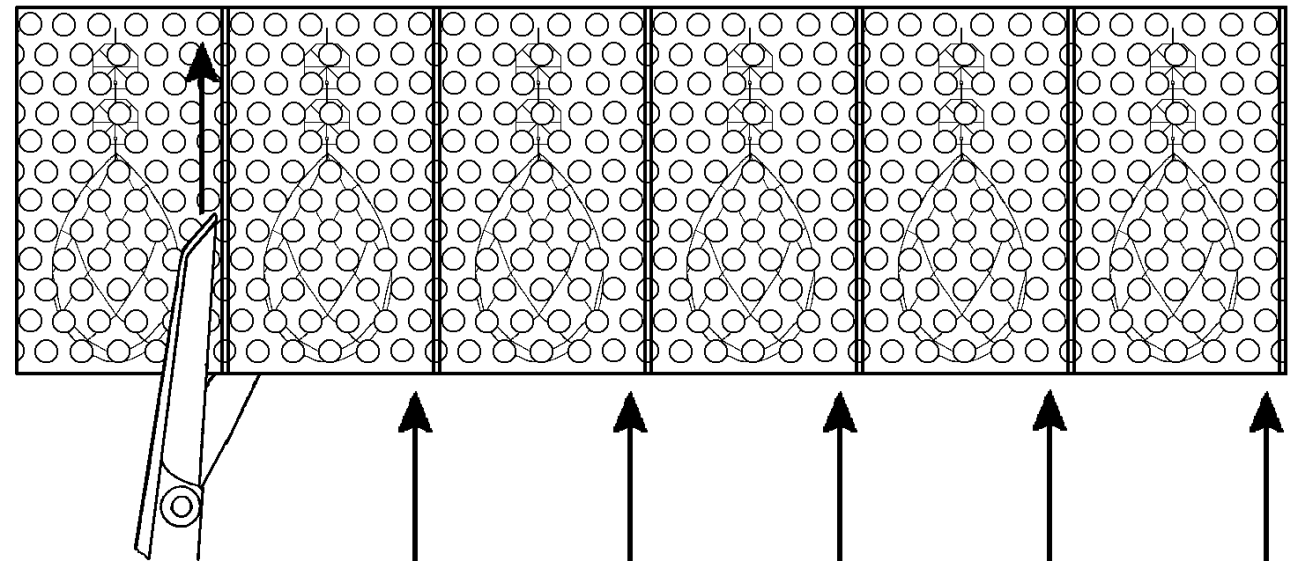

NOTE: Work on one crystal set at a time. Follow the black line from top to bottom according to the numbered steps on the trim diagram.

Instructions for crystal trimming
STEPS 22 - 56

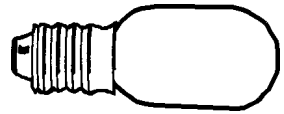

You will need 1 - T7
15 Watts Max
(Center Light) **23**



You will need 16 - C10
25 Watts Recommended
60 Watts Max

Install bulbs and be
sure to test fixture
BEFORE trimming.

Crystal Set #1 in Black

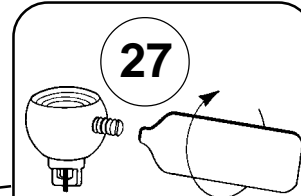

27
Tighten With
Tool Provided.

FIXTURE INCLUDES:
Hanger Hardware
Trim
Frame
1 - T7 Light Bulb
DOES NOT INCLUDE:
C10 - Light Bulbs

Crystal Set #2 in Black

46
N4003-**

45
N4007-**

44
N4019-**

43
N4017-**

#9419

#9419

#9302

#9418

#9319

