

MAINTENANCE:

Use a soft, lint - free cloth to clean the metal frame.

**UNDER NO CIRCUMSTANCES
SHOULD METAL POLISHES, CLEANERS,
ABRASIVES OR AEROSOL SPRAYS
BE USED.**

While the latest finishing techniques have been used on the metal frame, such finish cannot be unconditionally guaranteed. The main cause of deterioration, apart from certain atmospheric conditions, is improper cleaning.

To clean the crystals, polish with a damp chamois.

You are cleaning delicate jewelry... Take the greatest care.

IMPORTANT:

Do not clean crystals in a dishwasher. The finish of the metal clips and hangers will be ruined and the crystals may be damaged.

CHANDELIER 3570- _____ - _____ TRIM DIAGRAM

(Finish Option) (Trim Option)

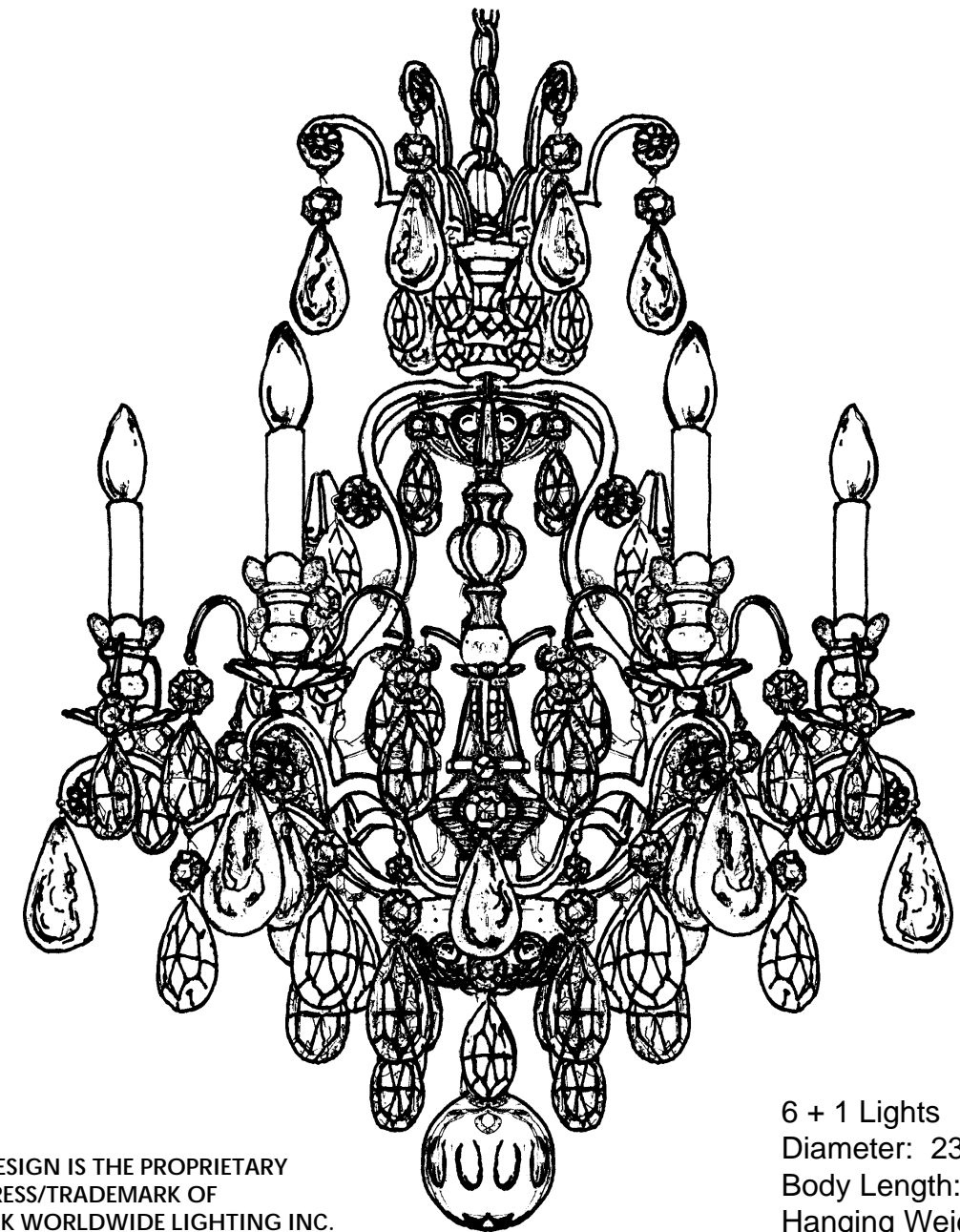

THIS DESIGN IS THE PROPRIETARY TRADE DRESS/TRADEMARK OF SCHONBEK WORLDWIDE LIGHTING INC.

6 + 1 Lights
Diameter: 23-1/2"
Body Length: 27"
Hanging Weight: 29 lbs.

SCHONBEK®

**Follow steps in exact order
Save this trim diagram for future reference**

1

IMPORTANT

Person who opens carton should record the following information for future service.

CODE # _____ Four-digit number on outside of carton.
PACKER # _____ See crystal package label.
ORDER # _____ See crystal package label.

SCHONBEK IS A WORLD LEADER IN CHANDELIER DESIGN. PATENTS INCLUDE:
#5,222,805 & #D374,103

Instructions for electrician
STEPS 2 - 21

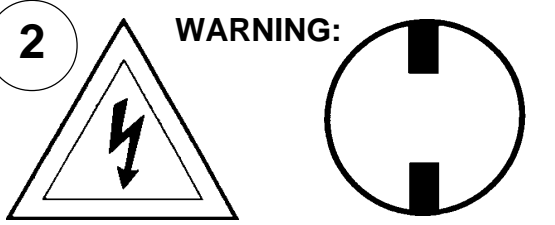
2 **WARNING:** 
Electrical Danger Turn Power Off

All electrical components must be installed by a licensed electrician in accordance with the National Electric Code and the appropriate local electrical codes.

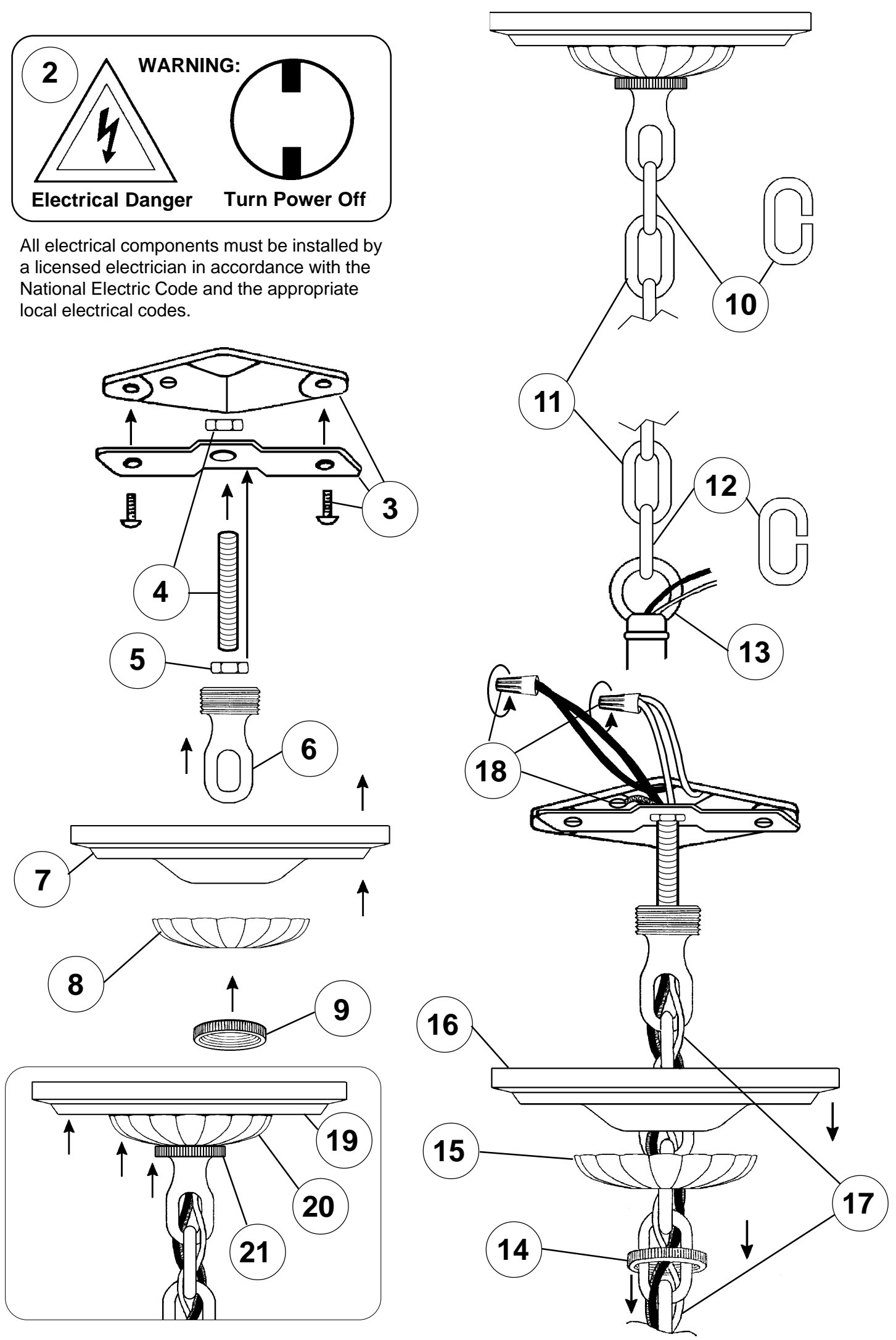

SET #1

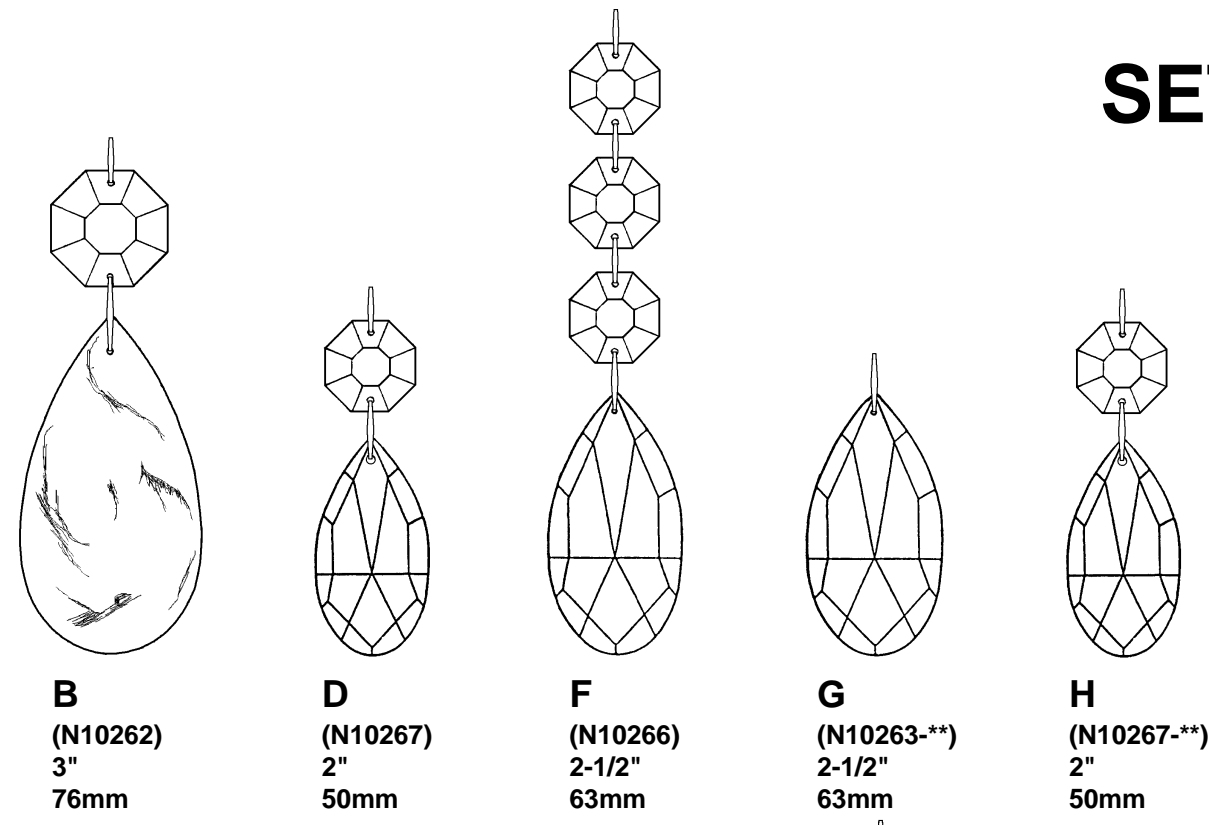

SET #2

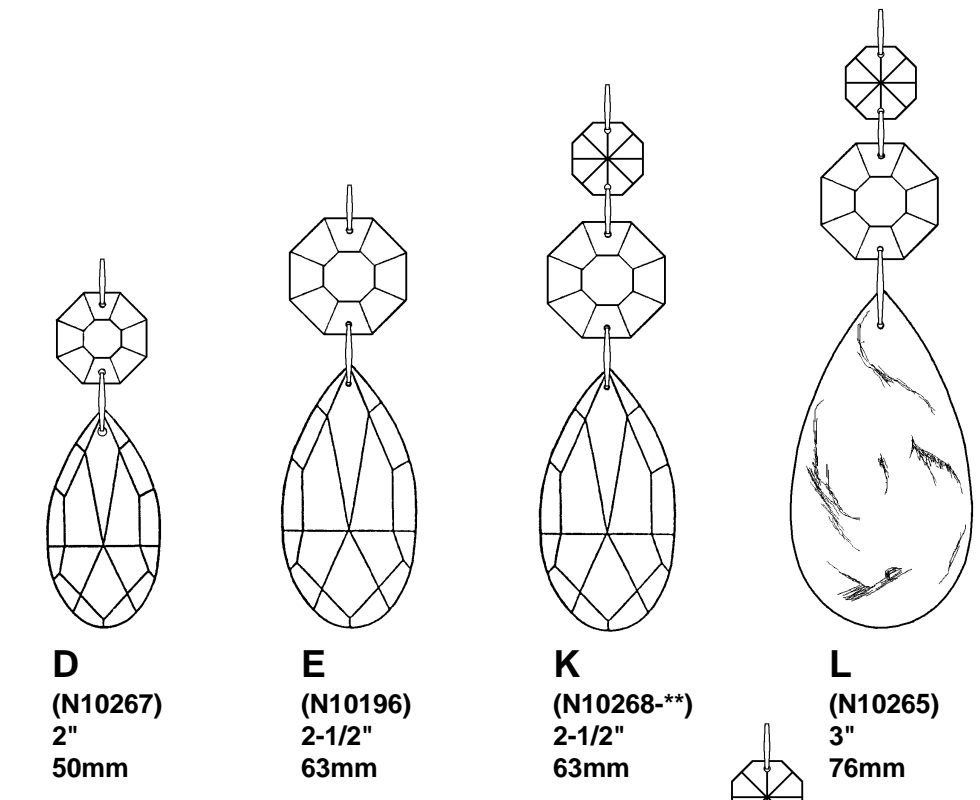

SET #3

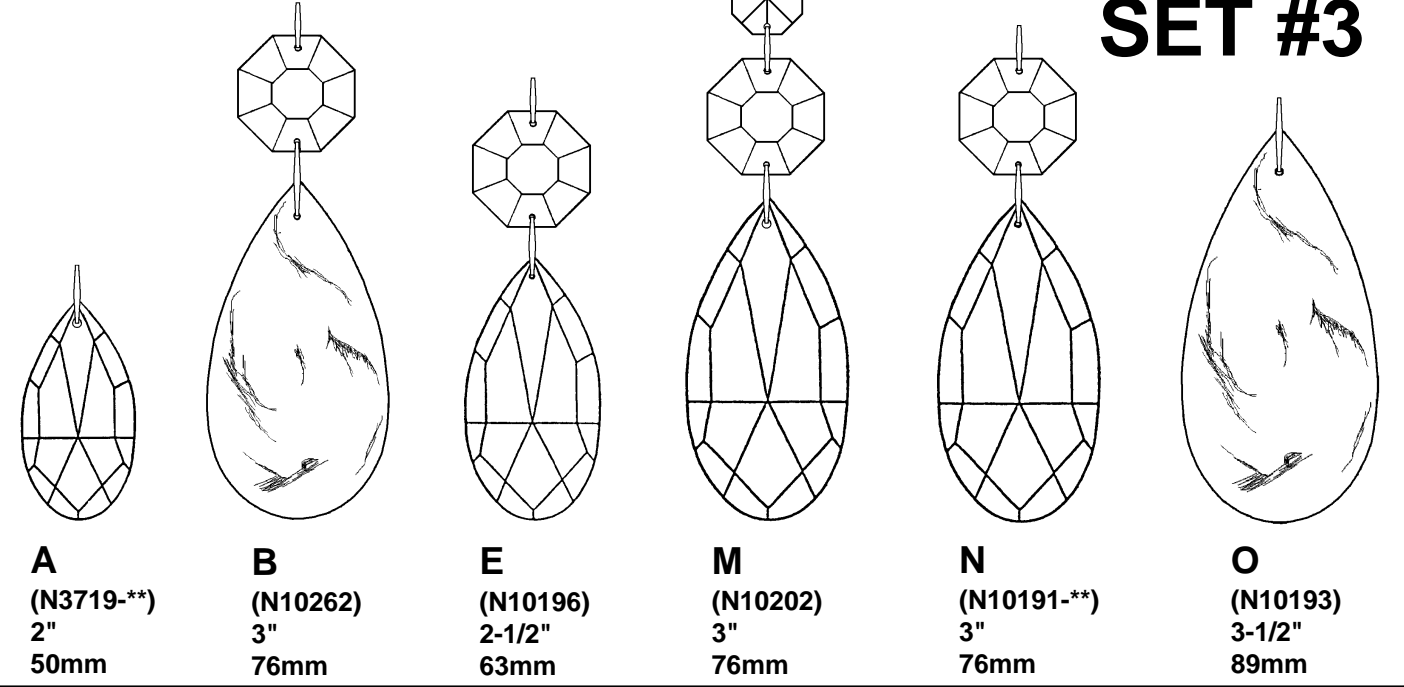

Crystal Set #3 in Black

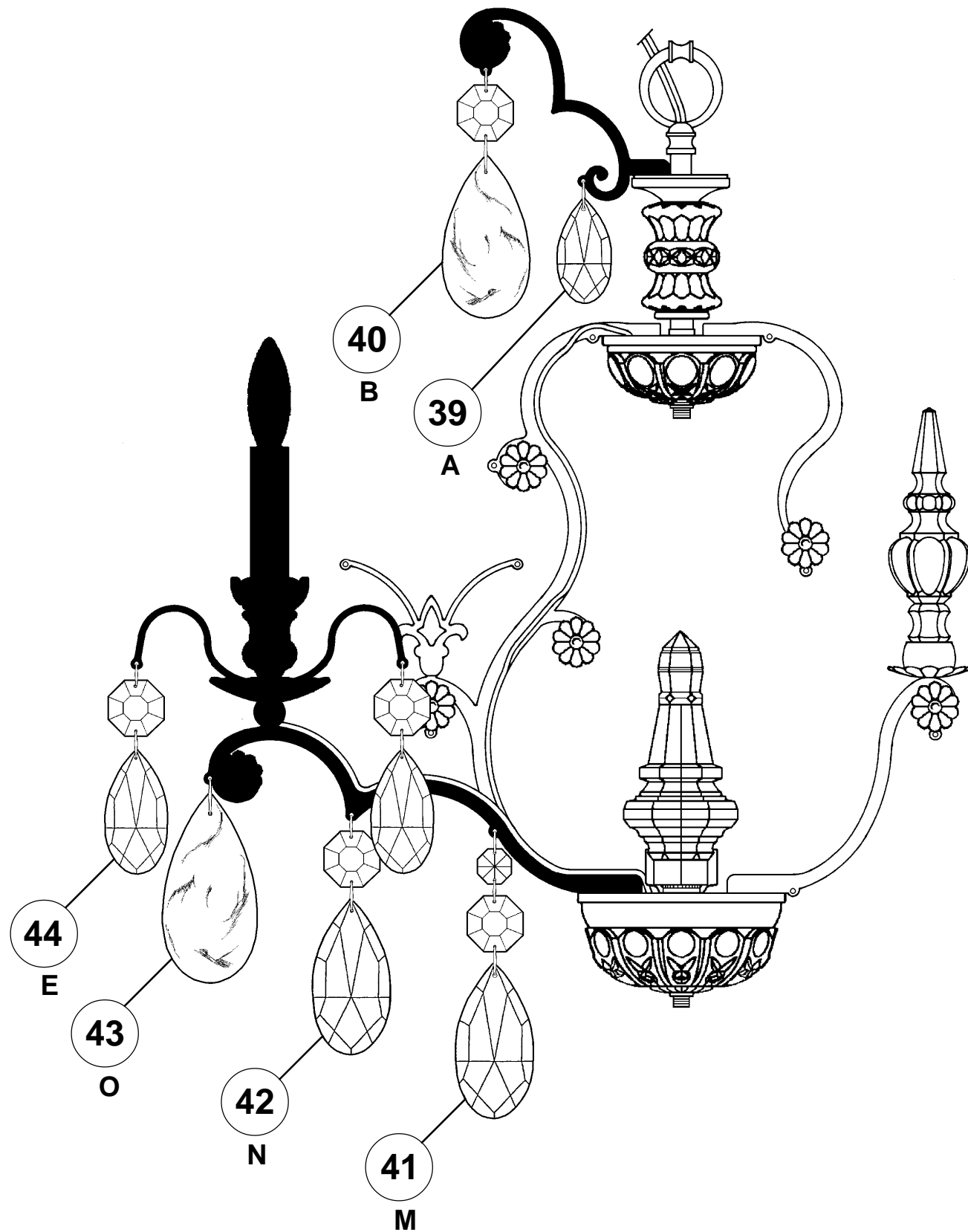

For easy removal of crystal from bubble pack, please cut along pouches on the inside of the seam. Gently remove crystal from the side of the pouch.

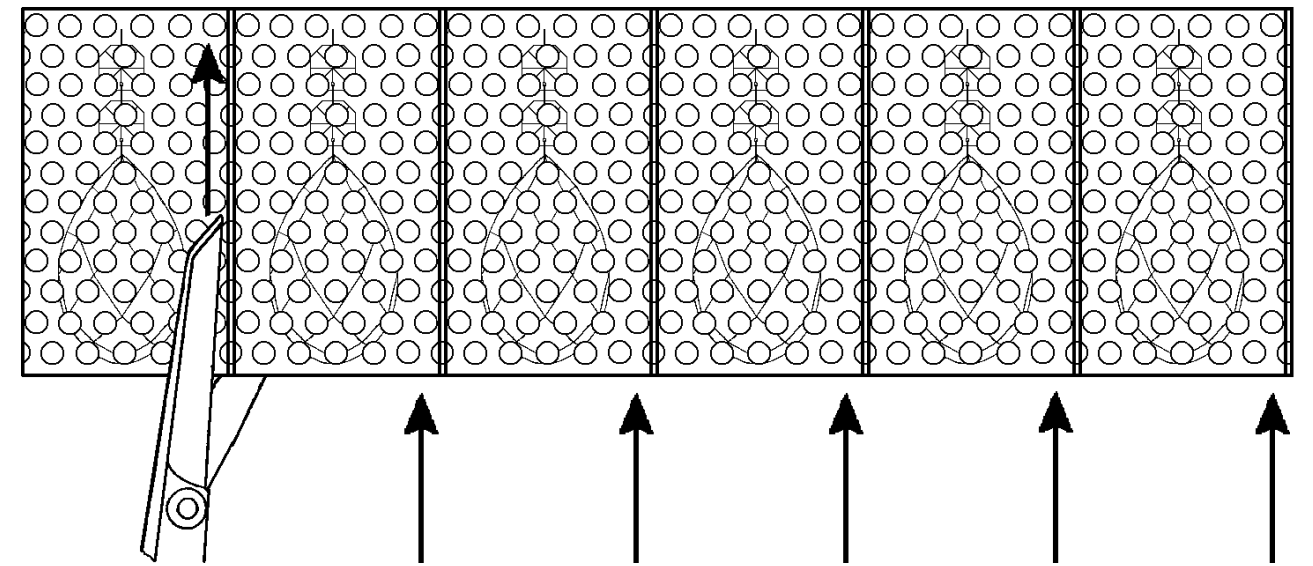

NOTE: Work on one crystal set at a time. Follow the black line from top to bottom according to the numbered steps on the trim diagram.

Instructions for crystal trimming STEPS 22 - 44

SPARE PARTS KIT
PROVIDED.

FIXTURE INCLUDES:
Hanger Hardware
Trim - Frame
1 - T7 Light Bulb

DOES NOT INCLUDE:
C10 - Light Bulbs

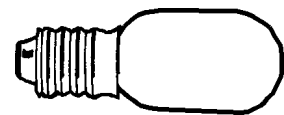

You will need 1 - T7
15 Watts Max
(Center Light)

23



You will need 6 - C10
25 Watts Recommended
60 Watts Max

Install bulbs and be
sure to test fixture
BEFORE trimming.

Crystal Set #1 in Black

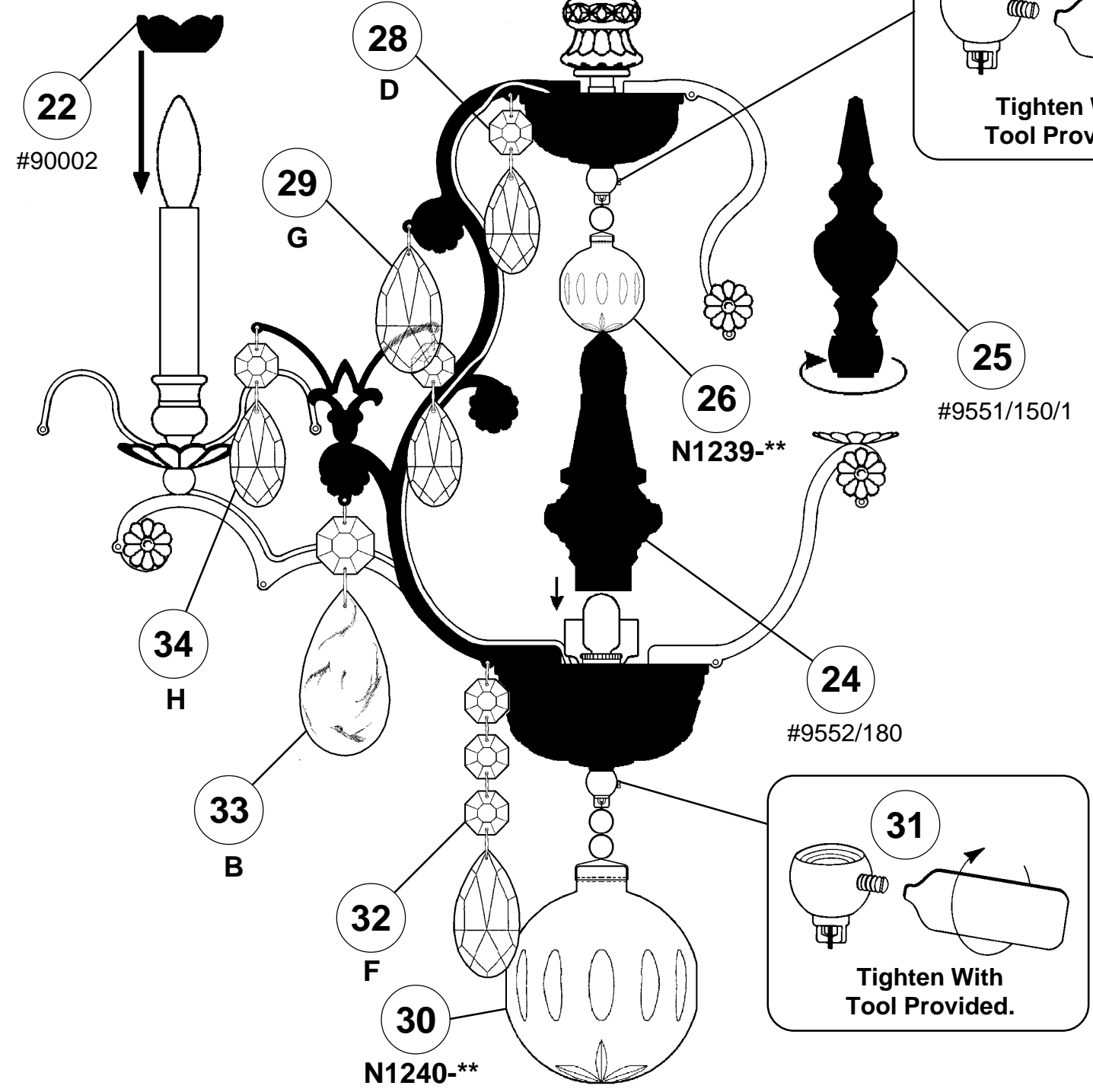

Crystal Set #2 in Black

