

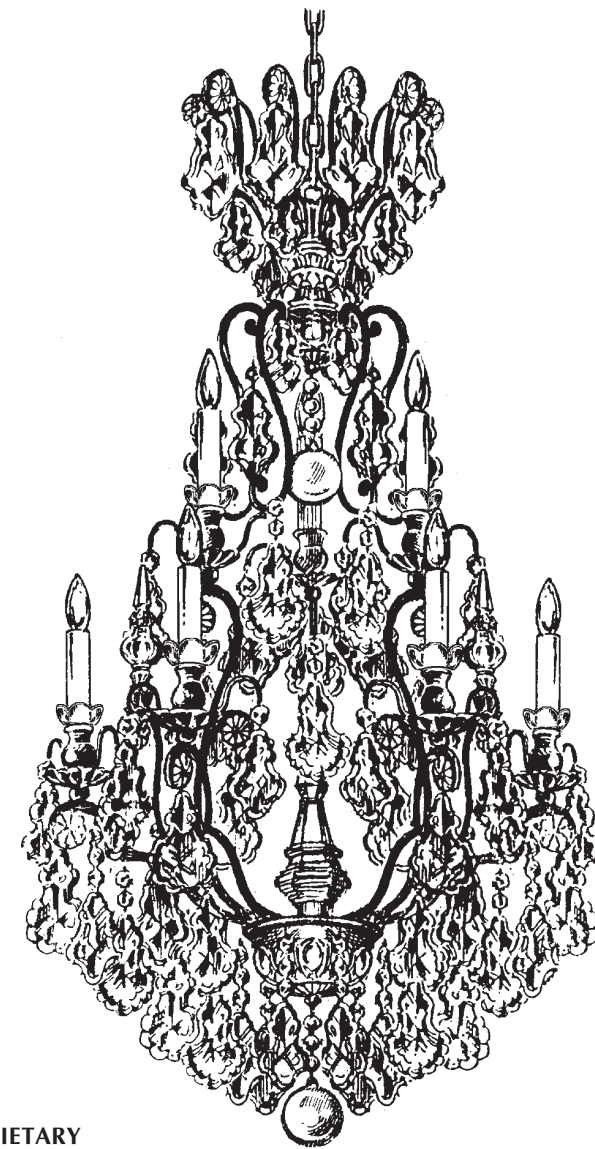

SCHONBEK®

VERSAILLES 2780- _ _ _



THIS DESIGN IS THE PROPRIETARY TRADE DRESS/TRADemark OF SWAROVSKILIGHTING, LTD.

9 + 1 Lights
Diameter: 21"
Body Length: 40"
Hanging Weight: 30 lbs.



SCHONBEK®

MAX 60 W	MAX 15 W	110-120 V						

SCHONBEK® is a member of the Swarovski group.

All electrical components must be installed by a licensed electrician in accordance with the National Electric Code and the appropriate local electrical codes.

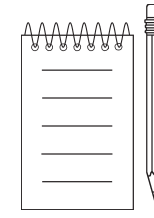
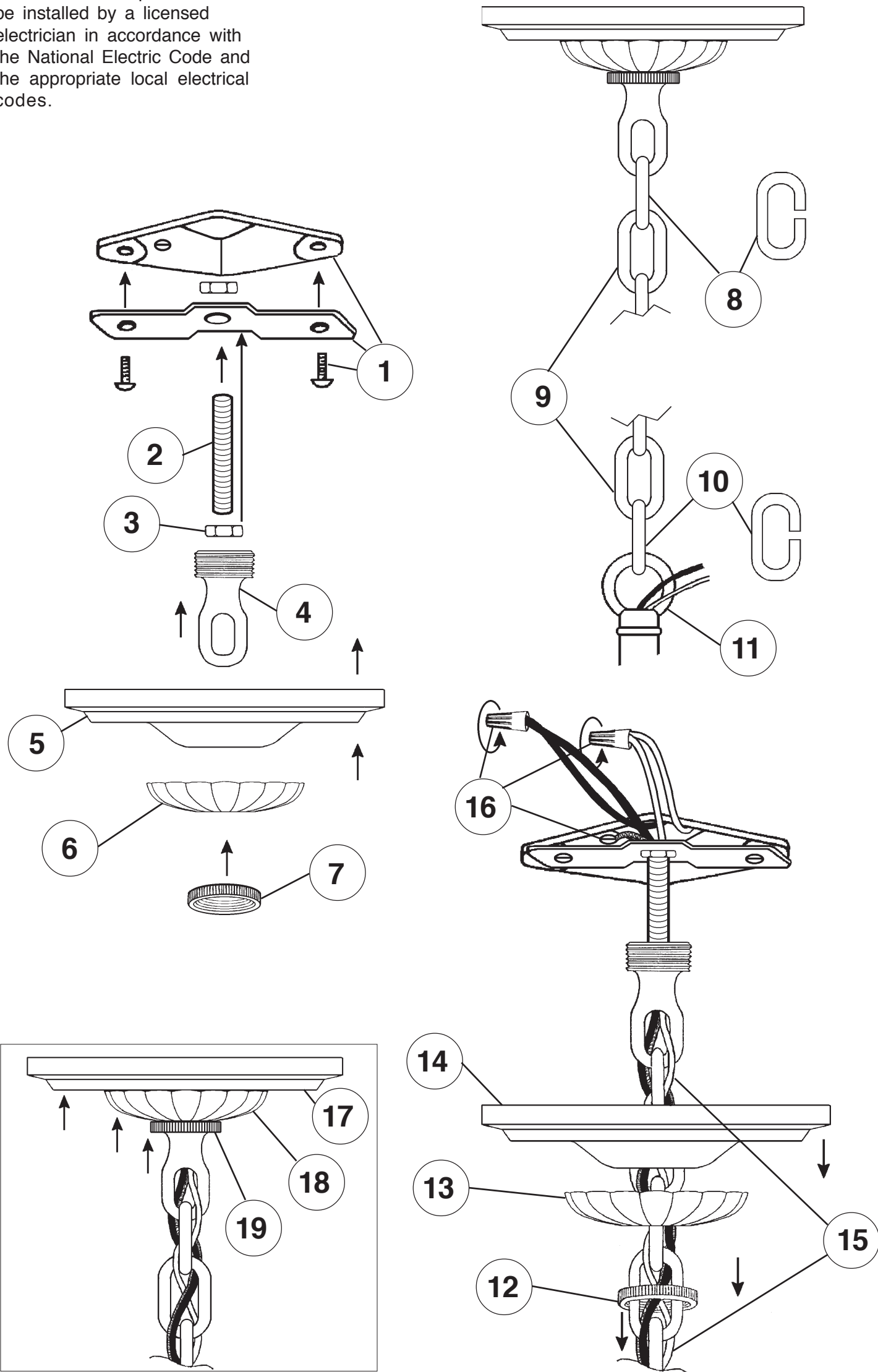

Crystal Set #3 in Black

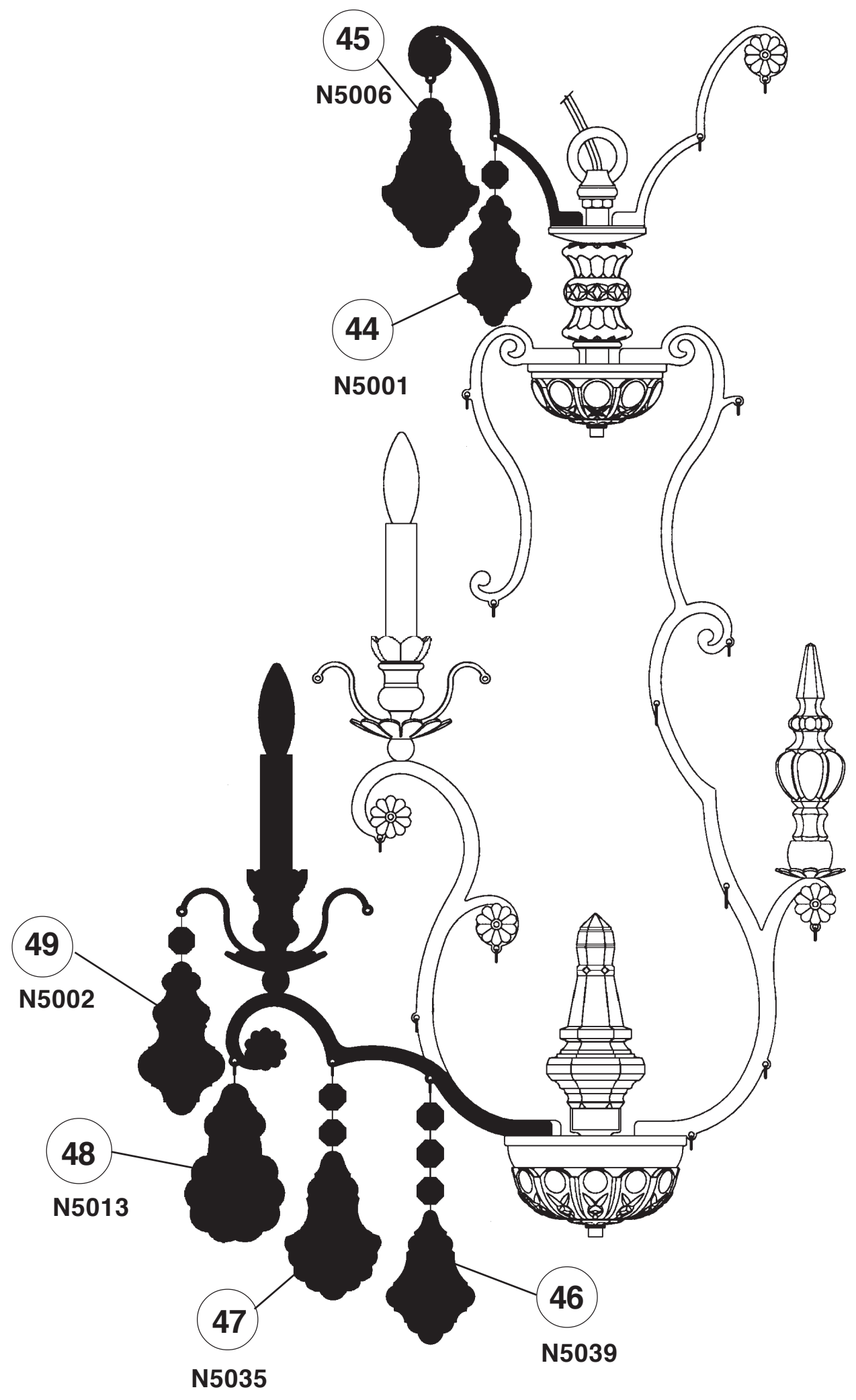

SET #1

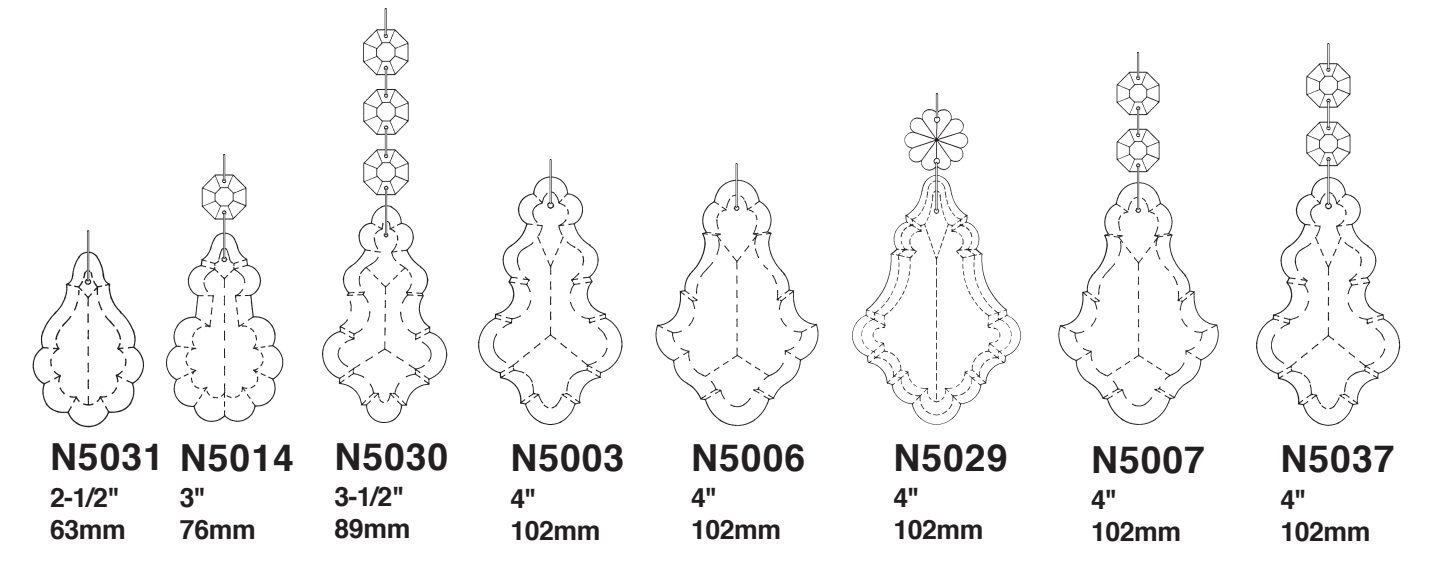

SET #2

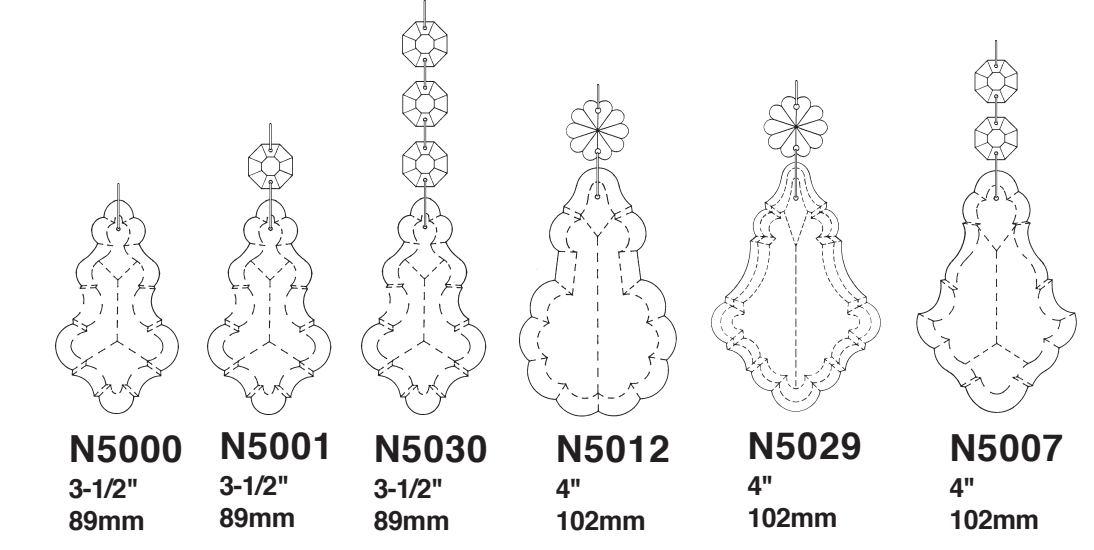

SET #3

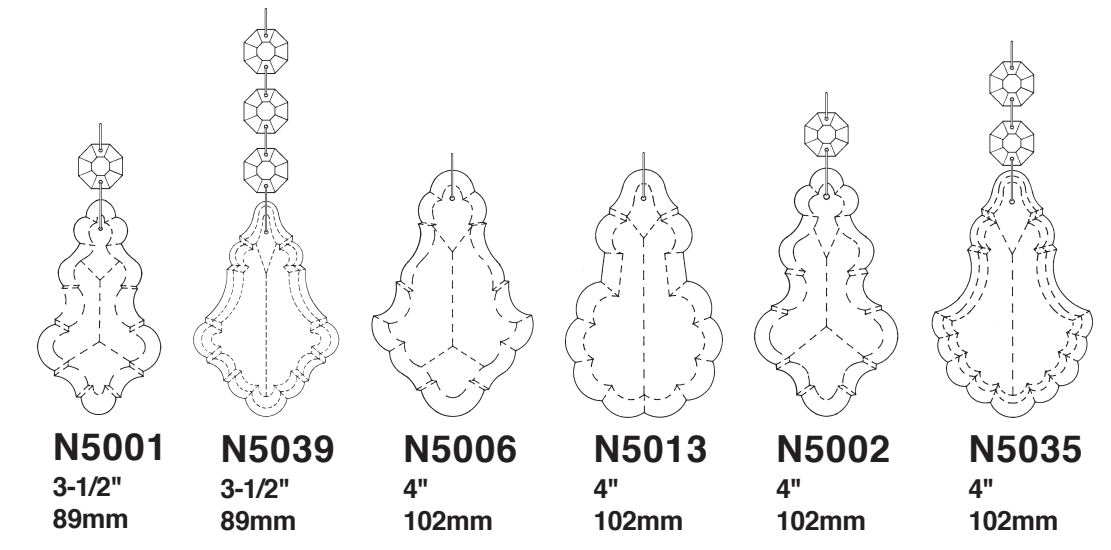

Crystal Set #1 in Black

Crystal Set #2 in Black

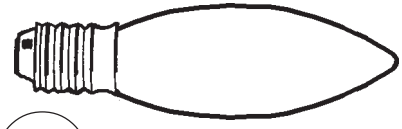

22 9 - B10
60 Watts Max
25 Watts Recommend

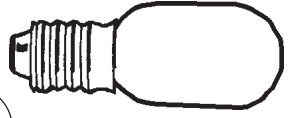

20 1 - T7
15 Watts Max
(Center Light)

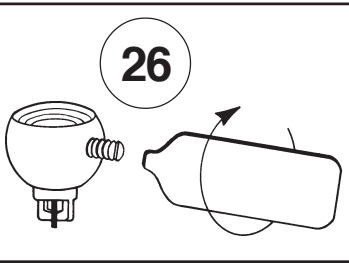

26

21

90002



25

28

N5003

23

9552/180

33

32

N434-**

27

N5031

30

N5029

31

N5006

24

29

N5014

36

N5037

35

N5007

34

N5030

38

N5001

37

N5000

39

N5000

43

N5029

42

N5012

41

N5007

40

N5030

9418

9302/0

9319

