

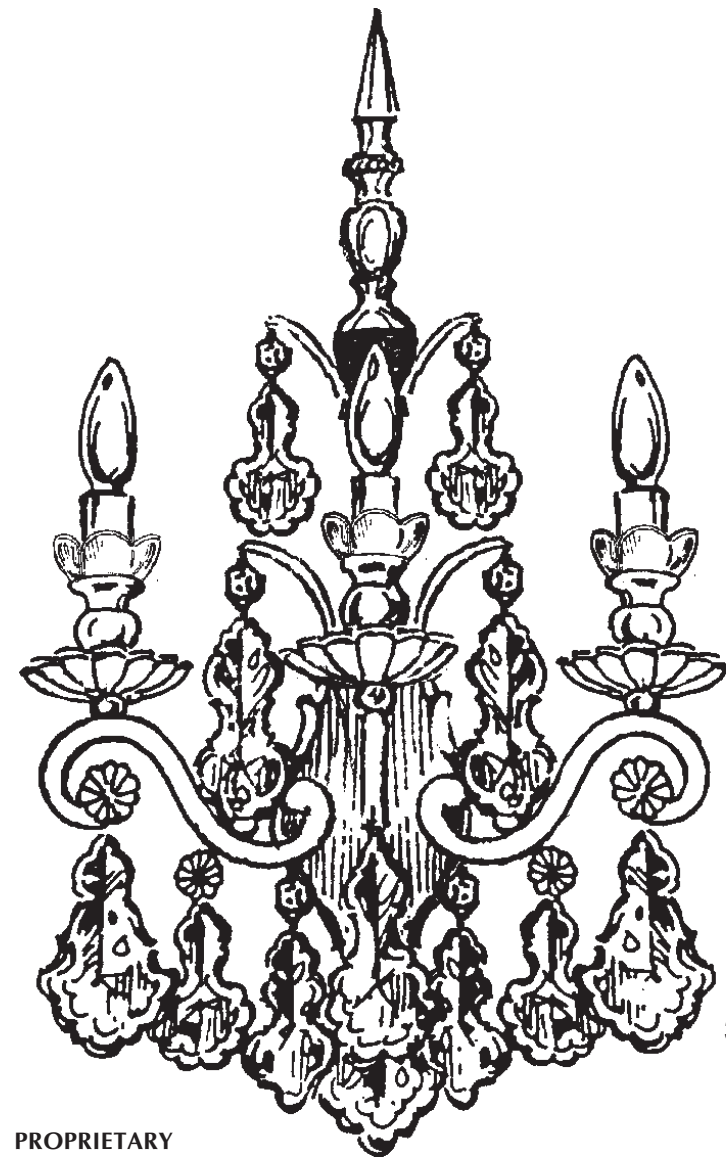

**SCHONBEK®**

VERSAILLES 2762- \_ \_ \_



3 Lights  
Diameter: 15"  
Body Length: 22"  
Extension: 8"  
Hanging Weight: 7 lbs.

**T**HIS DESIGN IS THE PROPRIETARY TRADE DRESS/TRADEMARK OF SWAROVSKILIGHTING, LTD.



**SCHONBEK®**

MAX 60 W		110-120 V						

SCHONBEK® is a member of the Swarovski group.

All electrical components must be installed by a licensed electrician in accordance with the National Electric Code and the appropriate local electrical codes.

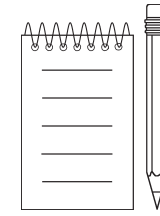
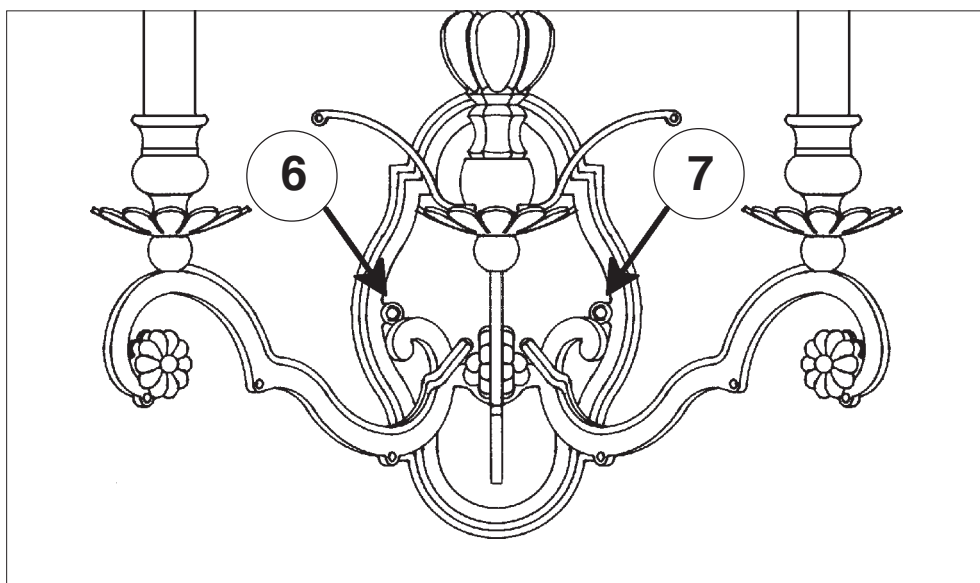
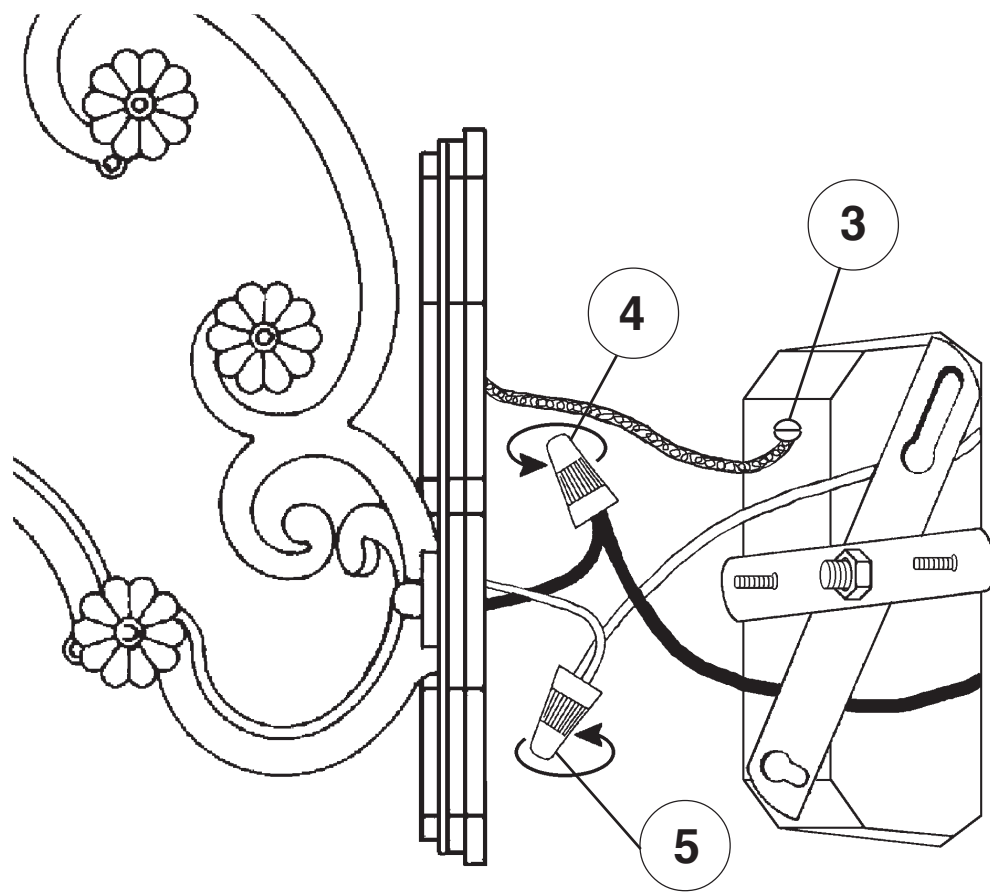
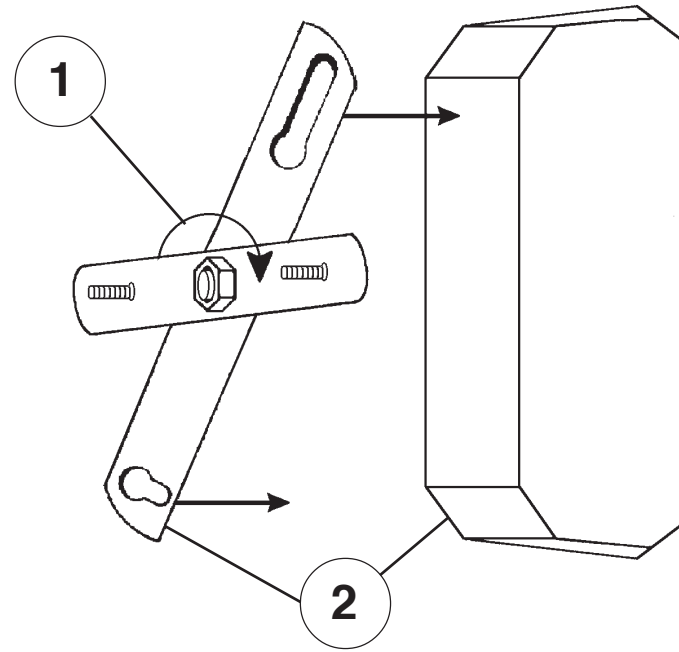

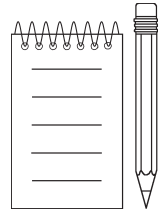

# SET #1

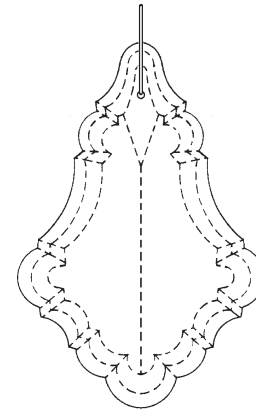

**N5024**  
3"  
76mm

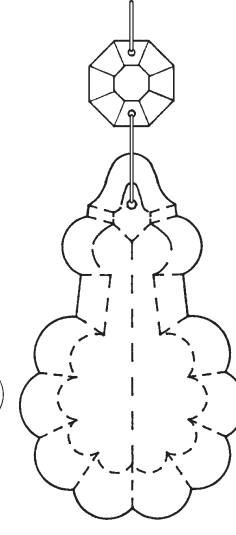

**N5014**  
3"  
76mm

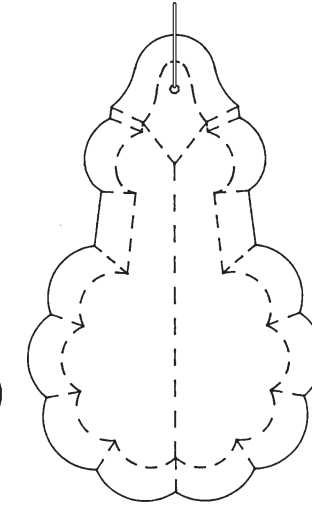

**N5013**  
4"  
102mm

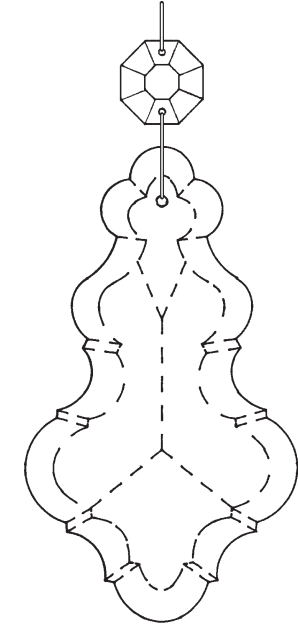

**N5002**  
4"  
102mm

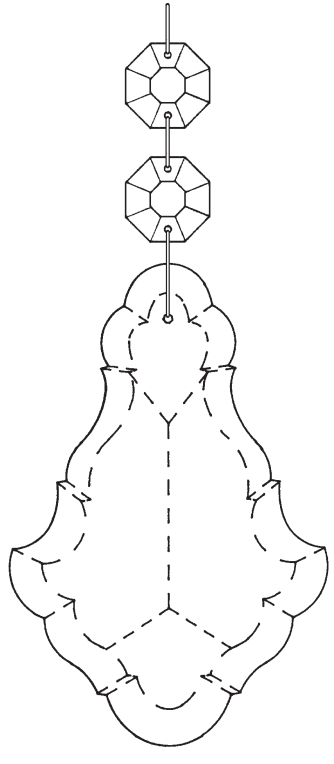

**N5007**  
4"  
102mm

# SET #2

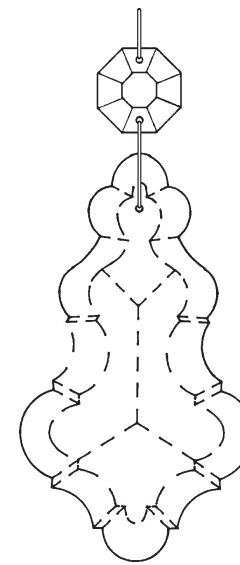

**N5001**  
3-1/2"  
89mm

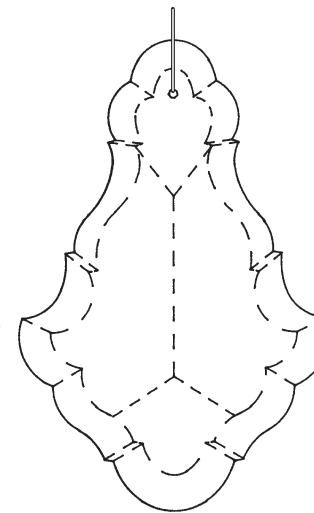

**N5006**  
4"  
102mm

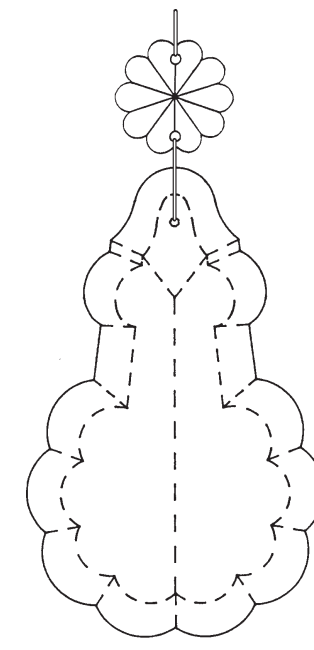

**N5012**  
4"  
102mm

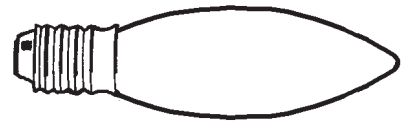

**9** 3 - B10  
60 Watts Max  
25 Watts Recommend

**Crystal Set #1 in Black**

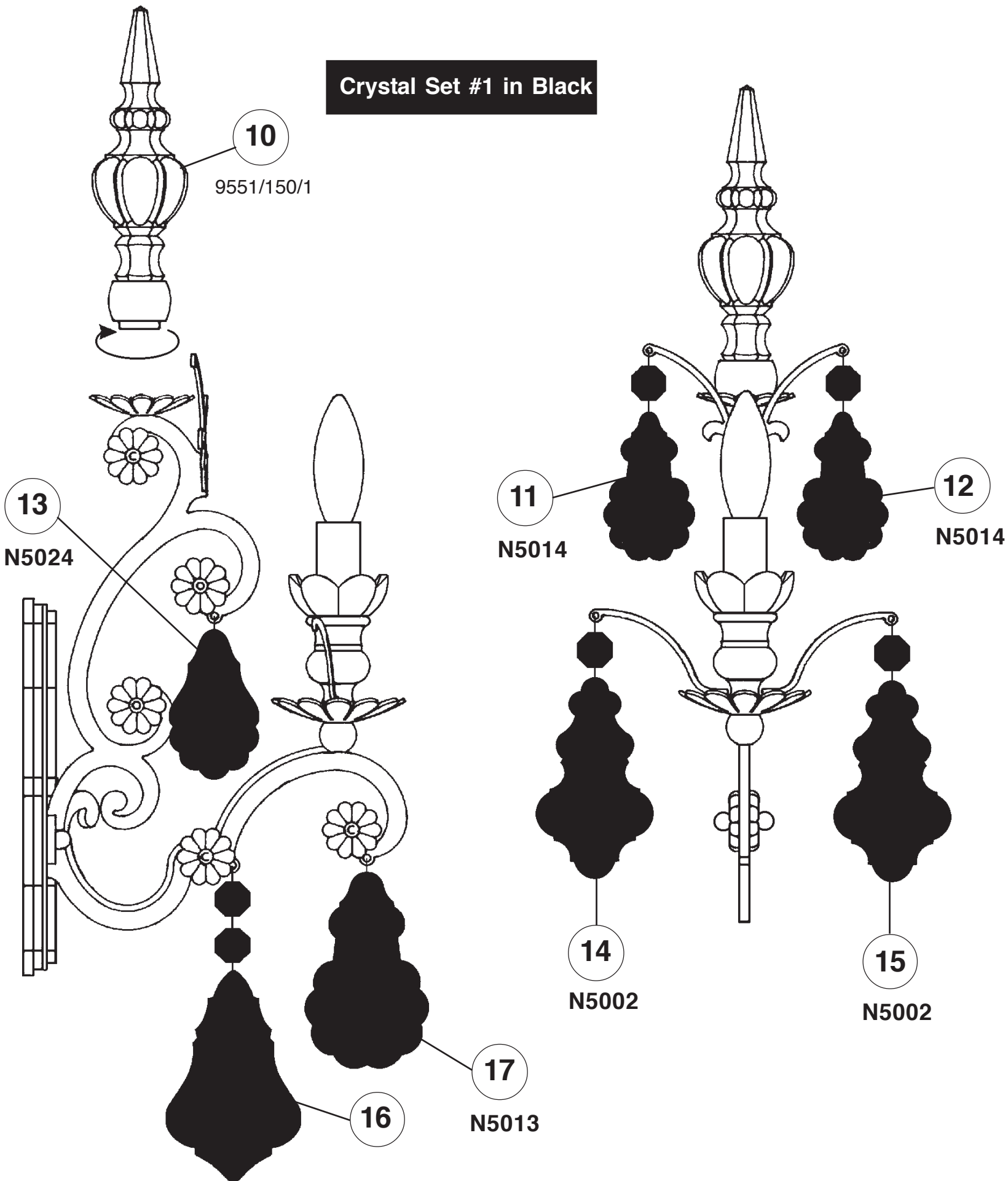

**Crystal Set #2 in Black**

